

SWIR Series Camera User Manual

Version 2.2
2024.10.17



All materials related to this publication are subject to change without notice and are copyrighted by ToupTek Photonics.

Please download the latest version from touptek.com.

content

SWIR SERIES CAMERA USER MANUAL	1
1 PRODUCT DESCRIPTION AND FEATURES	5
2 CAMERA LIST	6
2.1 SWIR 400-1700 CAMERA MODEL PARAMETERS(22)	6
2.2 SWIR 900-1700 CAMERA MODEL PARAMETERS(14)	7
3 SWIR 400-1700 CAMERA MODEL SPECIFICATIONS	9
3.1 SWIR 400-1700 5MP 3.45um IMX992(5).....	9
3.1.1 SWIR5000KMA	9
3.1.2 SWIR5000KMA-10G.....	10
3.1.3 SWIR5000KMA-CL100	11
3.1.4 SWIR5000KMB.....	12
3.1.5 SWIR5000KMB-UMV	13
3.1.6 IMX992 QE Curve.....	14
3.1.7 IMX992 Camera performance parameters	14
3.2 SWIR 400-1700 3MP 3.45um IMX993(5).....	15
3.2.1 SWIR3000KMA	15
3.2.2 SWIR3000KMA-10G.....	16
3.2.3 SWIR3000KMA-CL150	17
3.2.4 SWIR3000KMB.....	19
3.2.5 SWIR3000KMB-UMV	20
3.2.6 IMX993 QE Curve.....	21
3.2.7 IMX993 Camera performance parameters	21
3.3 SWIR 400-1700 1.3MP 5um IMX990(6).....	22
3.3.1 SWIR1300KMA	22
3.3.2 SWIR1300KMA-G.....	23
3.3.3 SWIR1300KMA-CL200	24
3.3.4 SWIR1300KMB.....	25
3.3.5 SWIR1300KMB-G.....	26
3.3.6 SWIR1300KMB-UMV.....	27
3.3.7 IMX990 QE Curve.....	28
3.3.8 IMX990 Camera performance parameters	28
3.4 SWIR 400-1700 0.33MP 5um IMX991(6).....	29
3.4.1 SWIR330KMA	29
3.4.2 SWIR330KMA-G.....	30
3.4.3 SWIR330KMA-CL400	31
3.4.4 SWIR330KMB.....	32
3.4.5 SWIR330KMB-G.....	33
3.4.6 SWIR330KMB-UMV	34
3.4.7 IMX991 QE Curve.....	35
3.4.8 IMX991 Camera performance parameters	35
4 SWIR 900-1700 CAMERA MODEL SPECIFICATIONS	36
4.1 SWIR 900-1700 1.3MP 15um(4)	36
4.1.1 SWIR1302KMB-U200.....	36
4.1.2 SWIR1302KMB-10G.....	37
4.1.3 SWIR1302KMA-CL200 China Produced	38
4.1.4 SWIR1302KMB-CL200	39
4.1.5 SWIR1302 QE Curve.....	40

4.1.6	SWIR1302 Frame rate and ROI frame rate.....	40
4.2	SWIR 900-1700 0.33MP 15 μ m(11)	41
4.2.1	SWIR331KMA-CL China Produced(3).....	41
4.2.2	SWIR331KMB-CL(3).....	42
4.2.3	SWIR331KMB-G(3).....	43
4.2.4	SWIR331KMB-10G.....	44
4.2.5	SWIR331KMB-U700.....	45
4.2.6	SWIR331 QE Curve.....	46
4.2.7	SWIR331 Frame rate and ROI frame rate.....	46
5	CAMERA FUNCTIONS AND FEATURES.....	48
5.1	10G / 5G / 2.5G / GIGE CAMERA SPECIFICATION	48
5.2	CAMERALINK CAMERA SPECIFICATION.....	48
5.3	CAMERA OPERATION MODE	48
5.4	BIT DEPTH AND ROI CONTROL.....	48
5.5	BANDWIDTH AND PRECISE FRAME RATE CONTROL	48
5.5.1	Bandwidth	48
5.5.2	Precise frame rate control.....	48
5.6	DDR3 BUFFER	48
5.7	BINNING	48
5.8	DC12V POWER SUPPLY AND COOLING SYSTEM.....	49
5.9	CAMERA PERFORMANCE ANALYSIS	49
5.10	LENS DESIGN GUIDELINES	49
5.11	FILTER	51
5.12	RG VERSION DESCRIPTION	51
5.13	CO VERSION DESCRIPTION	52
6	CAMERA DIMENSIONS AND PORT.....	53
6.1	SWIR 400-1700 CAMERA DIMENSIONS	53
6.2	SWIR 400-1700 CAMERA PORT	54
6.3	SWIR 900-1700 CAMERA DIMENSIONS.....	56
6.3.1	SWIR331 Camera dimensions.....	56
6.3.2	SWIR1302 Camera dimensions.....	57
6.4	SWIR 900-1700 CAMERA PORT	59
7	PACKING LIST	61
7.1	SWIR 400-1700 CAMERA PACKING LIST	61
7.2	SWIR 900-1700 CAMERA PACKING LIST	64
8	EXTERNAL IO CONNECTOR AND ELECTRICAL CHARACTERISTICS.....	68
8.1	SWIR 400-1700 CAMERA PIN SIGNAL	68
8.2	SWIR 900-1700 CAMERA PIN SIGNAL	68
8.3	I/O ELECTRICAL CHARACTERISTICS.....	69
8.3.1	Opto-isolated input circuit (line0).....	69
8.3.2	Opto-isolated output circuit (line1).....	69
8.3.3	Input and output I/O circuit (line2/line3).....	70
9	TOUPVIEW APPLICATION.....	73
9.1	APPLICATION INSTALLATION	73
9.2	INTRODUCTION TO TOUPVIEW	73
9.2.1	User interface design.....	73
9.2.2	Professional Camera Control Sidebar.....	74
9.2.3	Professional and practical image processing functions	74

9.2.4	<i>Super compatibility</i>	74
9.2.5	<i>Basic hardware requirements</i>	74
9.3	TRIGGER MODE AND ITS CONFIGURATION	75
9.3.1	<i>Video mode and Trigger mode</i>	75
9.3.2	<i>Trigger Sources and their capture style</i>	75
9.3.3	<i>The trigger capture and IO Control configurations</i>	77
9.4	COOLING	81
9.5	SOFTWARE DEVELOPMENT INSTRUCTIONS	82
9.5.1	<i>SDK description</i>	82
9.5.2	<i>SDK support platform</i>	82
9.5.3	<i>Introduction to SDK content</i>	82
9.5.4	<i>Third-party interface software</i>	84
10	CAMERALINK CAMERA APPLICATION	85
10.1	CONNECTION TO THE CAMERALINK	85
10.2	SOFTWARE INSTALLATION	85
10.2.1	<i>Install SDK</i>	85
10.2.2	<i>Install options</i>	85
10.2.3	<i>Install the driver</i>	86
10.3	CONFIGURE THE DELSA CAPTURE CARD	86
10.3.1	<i>Serial port configuration</i>	86
10.3.2	<i>CameraLink mode configured</i>	87
10.3.3	<i>Configuring CameraLink Receiving</i>	88
10.3.4	<i>CameraLink Receiving the configuration content</i>	89
10.4	USING GENICAM.....	91
10.4.1	<i>Communication Settings</i>	91
10.5	DESCRIPTION OF GENICAM.....	92
10.5.1	<i>Device Information and control</i>	93
10.5.2	<i>Image Format Controls</i>	93
10.5.3	<i>TEC Ctrl</i>	93
10.5.4	<i>Trigger ctrl</i>	94
10.6	THE MAIN FEATURES OF CAMERA	94
10.7	CAMERA COMMANDS	95
10.7.1	<i>Basic Formats</i>	95
10.7.2	<i>Dedicated Part Format</i>	96
10.7.3	<i>Definition of each register</i>	96
10.7.4	<i>Camera instruction example</i>	98
10.8	CL SDK & CLVIEW APPLICATION	98
10.8.1	<i>CL SDK</i>	99
10.8.2	<i>CLView application</i>	99
10.8.3	<i>CLCtrl software</i>	100

1 Product description and features

SWIR series is a USB3 / GigE / 10G / CameraLink interface short-wave infrared camera which adopts SONY or nationally produced InGaAs sensor. This camera has high quantum efficiency and high sensitivity, suitable for many common SWIR applications in different industrial segments.

- Semiconductor industry: Solar cell and chip inspection
- Agriculture: Spectral remote sensing applications by multi-rotor aircraft
- Recycling industry: Material sorting of plastics, waste and other materials
- Medical Imaging and Research: Hyperspectral and multispectral imaging
- Food industry: Quality inspection and classification
- Beverage industry: Liquid level detection in opaque containers
- Packing: Sealed inspection
- Glass industry: High temperature glass fluoroscopy defect detection
- Printing: Insight into hidden features
- Video surveillance: Visual enhancement (e.g. smoke perspective)
- Security: Detection of counterfeit goods, such as currency, wigs or skin

The basic features of SWIR series are as follows:

- The 400-1700nm version uses the SONY SenSWIR InGaAs sensor
- The 900-1700nm version uses the nationally produced InGaAs sensor
- The resolution covers 5MP-0.33MP
- Provide cooling version or uncooled version
- Precise temperature control, the temperature difference can reach 10-25 degrees Celsius
- Spectral response range: 400nm-1700nm/ 900-1700nm
- 15um /5um / 3.45um pixel size
- Global shutter
- USB3 / GigE / 10G / CameraLink / analog AV and other data interfaces
- Higher 14-bit ADC
- 4Gb memory
- Support external IO trigger control
- High framerate exceeding official parameters
- Support field update firmware
- Accept OEM custom development

2 Camera List

2.1 SWIR 400-1700 camera model parameters(22)

Model Number	Image Sensor	Pixel Size(μm)	Dynamic Range SNR	Data Interface	FPS/Resolution-8bit	Binning	Exposure Time Dimensions
5.0MP IMX992							
SWIR5000KMA 20240129	5.0M/IMX992(M,GS) 1/1.4”(8.94x7.09) Buit-in TEC	3.45x3.45	51.5dB 48.5dB	USB3	61.9@2560x2048 135.7@1280x1024	1x1 1x1	15us~60s 80mm
SWIR5000KMA-10G 20240930	5.0M/IMX992(M,GS) 1/1.4”(8.94x7.09) Buit-in TEC	3.45x3.45	51.5dB 48.5dB	10G	165@2560x2048 322@1280x1024	1x1 1x1	15us~60s 80mm
SWIR5000KMA-CL 20240930	5.0M/IMX992(M,GS) 1/1.4”(8.94x7.09) Buit-in TEC	3.45x3.45	51.5dB 48.5dB	CameraLink	100@2560x2048 322@1280x1024	1x1 1x1	15us~60s 80mm
SWIR5000KMB 20240129	5.0M/IMX992(M,GS) 1/1.4”(8.94x7.09) External TEC	3.45x3.45	51.5dB 48.5dB	USB3	61.9@2560x2048 135.7@1280x1024	1x1 1x1	15us~60s 80mm
SWIR5000KMB-UMV 20240129	5.0M/IMX992(M,GS) 1/1.4”(8.94x7.09) Without TEC	3.45x3.45	51.5dB 48.5dB	USB3	61.9@2560x2048 135.7@1280x1024	1x1 1x1	15us~60s 33mm
3.0MP IMX993							
SWIR3000KMA 20240612	3.0M/IMX993(M,GS) 1/1.8”(7.07x5.3) Buit-in TEC	3.45x3.45	51.5dB 48.5dB	USB3	93@2048x1536 176@1024x768	1x1 1x1	15us~60s 80mm
SWIR3000KMA-10G 20240930	3.0M/IMX993(M,GS) 1/1.8”(7.07x5.3) Buit-in TEC	3.45x3.45	51.5dB 48.5dB	10G	150@2048x1536 300@1024x768	1x1 1x1	15us~60s 80mm
SWIR3000KMA-CL 20240930	3.0M/IMX993(M,GS) 1/1.8”(7.07x5.3) Buit-in TEC	3.45x3.45	51.5dB 48.5dB	CameraLink	150@2048x1536 300@1024x768	1x1 1x1	15us~60s 80mm
SWIR3000KMB 20240612	3.0M/IMX993(M,GS) 1/1.8”(7.07x5.3) External TEC	3.45x3.45	51.5dB 48.5dB	USB3	93@2048x1536 176@1024x768	1x1 1x1	15us~60s 80mm
SWIR3000KMB-UMV 20240612	3.0M/IMX993(M,GS) 1/1.8”(7.07x5.3) Without TEC	3.45x3.45	51.5dB 48.5dB	USB3	93@2048x1536 176@1024x768	1x1 1x1	15us~60s 33mm
1.3MP IMX990							
SWIR1300KMA	1.3M/IMX990(M,GS) 1/2”(6.40x5.12) Buit-in TEC	5x5	58.7dB 52.6dB	USB3	200@1280x1024 392@640x512	1x1 1x1	15us~60s 80mm
SWIR1300KMA-G	1.3M/IMX990(M,GS) 1/2”(6.40x5.12) Buit-in TEC	5x5	58.7dB 52.6dB	GigE	90@1280x1024 253@640x512	1x1 1x1	15us~60s 80mm
SWIR1300KMA-CL	1.3M/IMX990(M,GS) 1/2”(6.40x5.12) Buit-in TEC	5x5	58.7dB 52.6dB	CameraLink	200@1280x1024 392@640x512	1x1 1x1	15us~60s 80mm
SWIR1300KMB	1.3M/IMX990(M,GS) 1/2”(6.40x5.12) External TEC	5x5	58.7dB 52.6dB	USB3	200@1280x1024 392@640x512	1x1 1x1	15us~60s 80mm
SWIR1300KMB-G	1.3M/IMX990(M,GS) 1/2”(6.40x5.12) External TEC	5x5	58.7dB 52.6dB	GigE	90@1280x1024 253@640x512	1x1 1x1	15us~60s 80mm
SWIR1300KMB-UMV 20231102	1.3M/IMX990(M,GS) 1/2”(6.40x5.12) Without TEC	5x5	58.7dB 52.6dB	USB3	223@1280x1024 428@640x512	1x1 1x1	15us~60s 33mm
0.33MP IMX991							
SWIR330KMA	0.33M/IMX991(M,GS) 1/4”(3.20x2.56) Buit-in TEC	5x5	58.7dB 52.6dB	USB3	400@640x512 753@320x256	1x1 1x1	15us~60s 80mm

SWIR330KMA-G	0.33M/IMX991(M,GS) 1/4"(3.20x2.56) Buit-in TEC	5x5	58.7dB 52.6dB	GigE	258.8@640x512 486.1@320x256	1x1 1x1	15us~60s 80mm
SWIR330KMA-CL	0.33M/IMX991(M,GS) 1/4"(3.20x2.56) Buit-in TEC	5x5	58.7dB 52.6dB	CameraLink	400@640x512 753@320x256	1x1 1x1	15us~60s 80mm
SWIR330KMB	0.33M/IMX991(M,GS) 1/4"(3.20x2.56) External TEC	5x5	58.7dB 52.6dB	USB3	400@640x512 753@320x256	1x1 1x1	15us~60s 80mm
SWIR330KMB-G	0.33M/IMX991(M,GS) 1/4"(3.20x2.56) External TEC	5x5	58.7dB 52.6dB	GigE	258.8@640x512 486.1@320x256	1x1 1x1	15us~60s 80mm
SWIR330KMB-UMV 20231102	0.33M/IMX991(M,GS) 1/4"(3.20x2.56) Without TEC	5x5	58.7dB 52.6dB	USB3	428.1@640x512 227.7@320x256	1x1 1x1	15us~60s 33mm

* SWIR1300KMB-UMV and SWIR330KMB-UMV can provide RG versions, Please refer specifically to 5.12.

2.2 SWIR 900-1700 camera model parameters(14)

Model Number	Image Sensor	Pixel Size(μm)	Dynamic Range SNR	Data Interface	FPS/Resolution-8bit	Nationally Index	Exposure Time Dimensions
1.3MP 1280 x 1024							
SWIR1302KMB-U200 2024Q3	1.3M/1280x1024 1.5" (19.2x15.36) Buit-in TEC	15x15	69.2dB 65.4dB	USB3	200@1280x1024	China produced of key chips	16us~1s 68mm
SWIR1302KMB-10G 2024Q3	1.3M/1280x1024 1.5" (19.2x15.36) Buit-in TEC	15x15	69.2dB 65.4dB	10G	200@1280x1024	China produced of key chips	16us~1s 68mm
SWIR1302KMA-CL200 2024Q3	1.3M/1280x1024 1.5" (19.2x15.36) Buit-in TEC	15x15	69.2dB 65.4dB	CameraLink	200@1280x1024	China produced devices	16us~1s 68mm
SWIR1302KMB-CL200 2024Q3	1.3M/1280x1024 1.5" (19.2x15.36) Buit-in TEC	15x15	69.2dB 65.4dB	CameraLink	200@1280x1024	China produced of key chips	16us~1s 68mm
0.33MP 640 x 512							
SWIR331KMB-U700	0.33M/640x512 3/4" (9.60x7.68) Buit-in TEC	15x15	70.6dB 63.0dB	USB3	724@640x512	China produced of key chips	16us~5s 68mm
SWIR331KMB-G125	0.33M/640x512 3/4" (9.60x7.68) Buit-in TEC	15x15	70.6dB 63.0dB	GigE	125@640x512	China produced of key chips	25us~5s 68mm
SWIR331KMB-G350	0.33M/640x512 3/4" (9.60x7.68) Buit-in TEC	15x15	70.6dB 63.0dB	GigE	360@640x512	China produced of key chips	25us~5s 68mm
SWIR331KMB-G700	0.33M/640x512 3/4" (9.60x7.68) Buit-in TEC	15x15	70.6dB 63.0dB	GigE	360@640x512 700@320x256	China produced of key chips	25us~5s 68mm
SWIR331KMA-CL500	0.33M/640x512 3/4" (9.60x7.68) Buit-in TEC	15x15	70.6dB 63.0dB	CameraLink	517@640x512	China produced devices	16us~1s 68mm
SWIR331KMA-CL700	0.33M/640x512 3/4" (9.60x7.68) Buit-in TEC	15x15	70.6dB 63.0dB	CameraLink	724@640x512	China produced devices	16us~1s 68mm
SWIR331KMA-CL1000 2024Q4	0.33M/640x512 3/4" (9.60x7.68) Buit-in TEC	15x15	70.6dB 63.0dB	CameraLink	1000@640x512	China produced devices	16us~1s 68mm
SWIR331KMB-CL500	0.33M/640x512 3/4" (9.60x7.68)	15x15	70.6dB 63.0dB	CameraLink	517@640x512	China produced	16us~1s 68mm

	Buit-in TEC					of key chips	
SWIR331KMB-CL700	0.33M/640x512 3/4" (9.60x7.68) Buit-in TEC	15x15	70.6dB 63.0dB	CameraLink	724@640x512	China produced of key chips	16us~1s 68mm

* Frame rate of SWIR331KMB-G700 is limited by network interface and can only reach 360fps at full resolution. Frame rate can be improved through ROI.
 * SWIR331KMB-U700 and SWIR331KMB-G125 can be provide C0versions, Please refer specifically to 5.13.

3 SWIR 400-1700 camera model specifications

3.1 SWIR 400-1700 5MP 3.45um IMX992(5)

3.1.1 SWIR5000KMA

Table 1 SWIR5000KMA camera specifications

Parameter	Model
	SWIR5000KMA 5.0M pixels 1/1.4" CMOS USB3.0 industrial camera Camera
Sensor model	Sony IMX992-AABA-C
Sensor Type	InGaAs
Spectral Range	400nm-1700nm
Pixel size	3.45 μm x 3.45 μm
Sensor size	1/1.4"
ADC	12 Bit / 8 Bit
Frame rate	8 Bit: 61.9fps@2560x2048、135.7fps@1280x1024 12 Bit: 35.5fps@2560x2048、135.7fps@1280x1024
Image Buffer	512MByte
Conversion Gain	10.3e/ADU (HCG) 17.29e/ADU (LCG)
Dynamic range	51.36dB (HCG) 51.47dB (LCG)
Readout Noise	111.88e (HCG) 186.61e (LCG)
Full Well	41.39ke (HCG) 69.92ke (LCG)
SNRmax	46.17dB (HCG) 48.45dB (LCG)
Sensitivity	TBD
Dark current	TBD
Gain range	1x-15x
Exposure time	15 μs -60sec
Shutter	Global shutter
Binning	Software2x2, 3x3, 4x4
Data interface	USB3.0
Digital I/O	One optical-coupling isolated input, one optical-coupling isolated output, two non-isolated input and output
Data Format	8bit / 12bit
Cooling performance	25°C below ambient temperature
Optical filter	400-1800nm(default); 1030-1800nm(optional)
CRA	2.35 Deg
General specification	
Power supply	Power with USB3.0 or 12V Power adapter
Power consumption	<2.1W(without cooling) / <25W(cooling)
Temperature	Working temperature -20~60°C, storage temperature -40~85°C
Humidity	20%-80%, no condensation
Size	80mm×80mm×45.5mm
Weight	<390g
Lens mount	C-mount
Software	ToupView/ SDK
Operating system	Win32/WinRT/Linux/macOS/Android
Certification	CE, FCC

3.1.2 SWIR5000KMA-10G

Table 2 SWIR5000KMA-10G camera specifications

Parameter	Model	SWIR5000KMA-10G 5.0M pixels 1/1.4" CMOS 10G industrial camera Camera
Sensor model		Sony IMX992-AABA-C
Sensor Type		InGaAs
Spectral Range		400nm-1700nm
Pixel size		3.45 μm x 3.45 μm
Sensor size		1/1.4"
ADC		12 Bit / 10 Bit / 8 Bit
Frame rate		8 Bit: 165fps@2560x2048、322fps@1280x1024 10 Bit: 150fps@2560x2048、290fps@1280x1024 12 Bit: 90fps@2560x2048、172fps@1280x1024
Image Buffer		512MByte
Conversion Gain		10.3e/ADU (HCG) 17.29e/ADU (LCG)
Dynamic range		51.36dB (HCG) 51.47dB (LCG)
Readout Noise		111.88e (HCG) 186.61e (LCG)
Full Well		41.39ke (HCG) 69.92ke (LCG)
SNRmax		46.17dB (HCG) 48.45dB (LCG)
Sensitivity		TBD
Dark current		TBD
Gain range		1x-15x
Exposure time		15 μs -60sec
Shutter		Global shutter
Binning		Software2x2, 3x3, 4x4
Data interface		GigE
Digital I/O		One optical-coupling isolated input, one optical-coupling isolated output, two non-isolated input and output
Data Format		8bit / 12bit
Cooling performance		25°C below ambient temperature
Optical filter		400-1800nm(default); 1030-1800nm(optional)
CRA		2.35 Deg
General specification		
Power supply		12V Power adapter
Power consumption		TBD
Temperature		Working temperature -20~60°C, storage temperature -40~85°C
Humidity		20%-80%, no condensation
Size		80mm×80mm×45.5mm
Weight		<390g
Lens mount		C-mount
Software		ToupView/ SDK
Operating system		Win32/WinRT/Linux/macOS/Android
Certification		CE, FCC

3.1.3 SWIR5000KMA-CL100

Table 3 SWIR5000KMA- CL100 camera specifications

Parameter	Model
	SWIR5000KMA- CL100 5.0M pixels 1/1.4" CMOS CameraLink industrial camera Camera
Sensor model	Sony IMX992-AABA-C
Sensor Type	InGaAs
Spectral Range	400nm-1700nm
Pixel size	3.45 μm x 3.45 μm
Sensor size	1/1.4"
ADC	12 Bit / 10 Bit
Frame rate	10Bit: 100fps@2560x2048、322fps@1280x1024 12 Bit: 61fps@2560x2048、187fps@1280x1024
Image Buffer	512MByte
Conversion Gain	10.3e/ADU (HCG) 17.29e/ADU (LCG)
Dynamic range	51.36dB (HCG) 51.47dB (LCG)
Readout Noise	111.88e (HCG) 186.61e (LCG)
Full Well	41.39ke (HCG) 69.92ke (LCG)
SNRmax	46.17dB (HCG) 48.45dB (LCG)
Sensitivity	TBD
Dark current	TBD
Gain range	1x-15x
Exposure time	15μs-60sec
Shutter	Global shutter
Binning	Nonsupport
Data interface	CameraLink
Digital I/O	One optical-coupling isolated input, one optical-coupling isolated output, two non-isolated input and output
Data Format	10bit / 12bit
Cooling performance	25°C below ambient temperature
Optical filter	400-1800nm(default); 1030-1800nm(optional)
CRA	2.35 Deg
General specification	
Power supply	12V Power adapter
Power consumption	TBD
Temperature	Working temperature -20~60°C, storage temperature -40~85°C
Humidity	20%-80%, no condensation
Size	75mm×75mm×81.9mm
Weight	<390g
Lens mount	C-mount
Software	ToupView/ SDK
Operating system	Win32/WinRT/Linux/macOS/Android
Certification	CE, FCC

3.1.4 SWIR5000KMB

Table 4 SWIR5000KMB camera specifications

Parameter	Model
	SWIR5000KMB
	5.0M pixels 1/1.4" CMOS USB3.0 industrial camera
	Camera
Sensor model	Sony IMX992-AABJ-C
Sensor Type	InGaAs
Spectral Range	400nm-1700nm
Pixel size	3.45 μm x 3.45 μm
Sensor size	1/1.4"
ADC	12 Bit / 8 Bit
Frame rate	8 Bit: 61.9fps@2560x2048、135.7fps@1280x1024 12 Bit: 35.5fps@2560x2048、135.7fps@1280x1024
Image Buffer	512MByte
Conversion Gain	10.3e/ADU (HCG) 17.29e/ADU (LCG)
Dynamic range	51.36dB (HCG) 51.47dB (LCG)
Readout Noise	111.88e (HCG) 186.61e (LCG)
Full Well	41.39ke (HCG) 69.92ke (LCG)
SNRmax	46.17dB (HCG) 48.45dB (LCG)
Sensitivity	TBD
Dark current	TBD
Gain range	1x-15x
Exposure time	15 μs -60sec
Shutter	Global shutter
Binning	Software2x2, 3x3, 4x4
Data interface	USB3
Digital I/O	One optical-coupling isolated input, one optical-coupling isolated output, two non-isolated input and output
Data Format	8bit / 12bit
Cooling performance	10°C below ambient temperature
Optical filter	400-1800nm(default); 1030-1800nm(optional)
CRA	2.35 Deg
	General specification
Power supply	Power with USB3.0 or 12V Power adapter
Power consumption	<2.1W(without cooling) / <25W(cooling)
Temperature	Working temperature -20~60°C, storage temperature -40~85°C
Humidity	20%-80%, no condensation
Size	80mm×80mm×45.5mm
Weight	<390g
Lens mount	C-mount
Software	ToupView/ SDK
Operating system	Win32/WinRT/Linux/macOS/Android
Certification	CE, FCC

3.1.5 SWIR5000KMB-UMV

Table 5 SWIR5000KMB-UMV camera specifications

Parameter	Model
	SWIR5000KMB-UMV
	5.0M pixels 1/1.4" CMOS USB3.0 industrial camera
	Camera
Sensor model	Sony IMX992-AABJ-C
Sensor Type	InGaAs
Spectral Range	400nm-1700nm
Pixel size	3.45 μm x 3.45 μm
Sensor size	1/1.4"
ADC	12 Bit / 8 Bit
Frame rate	8 Bit: 61.9fps@2560x2048、135.7fps@1280x1024 12 Bit: 35.5fps@2560x2048、135.7fps@1280x1024
Image Buffer	512MByte
Conversion Gain	10.3e/ADU (HCG) 17.29e/ADU (LCG)
Dynamic range	51.36dB (HCG) 51.47dB (LCG)
Readout Noise	111.88e (HCG) 186.61e (LCG)
Full Well	41.39ke (HCG) 69.92ke (LCG)
SNRmax	46.17dB (HCG) 48.45dB (LCG)
Sensitivity	TBD
Dark current	TBD
Gain range	1x-15x
Exposure time	15 μs -60sec
Shutter	Global shutter
Binning	Software2x2, 3x3, 4x4
Data interface	USB3
Digital I/O	One optical-coupling isolated input, one optical-coupling isolated output, one non-isolated input and output
Data Format	8bit / 12bit
Optical filter	400-1800nm(default); 1030-1800nm(optional)
CRA	2.35 Deg
	General specification
Power supply	Power with USB3.0
Power consumption	<2.11W
Temperature	Working temperature -20~60 $^{\circ}\text{C}$, storage temperature -40~85 $^{\circ}\text{C}$
Humidity	20%-80%, no condensation
Size	33mm×33mm×38mm
Weight	70g
Lens mount	C-mount
Software	ToupView/ SDK
Operating system	Win32/WinRT/Linux/macOS/Android
Certification	CE, FCC

3.1.6 IMX992 QE Curve

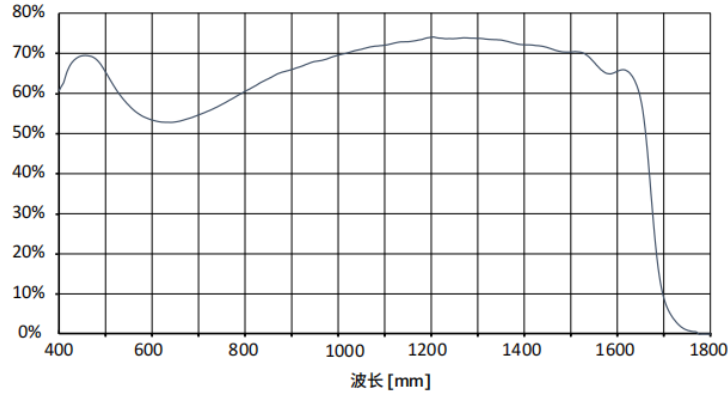

Figure 1 IM992 absolute quantum efficiency

3.1.7 IMX992 Camera performance parameters

The performance parameters of the camera are as follows:

- Maximum Resolution
- RAW 12 Bit mode
- Temperature: 5°C
- HCG

Table 6 SWR5000KMA Camera performance parameters

Gain Value	100	141	199	282	398	562	794	1500
e-/ADU	10.30	7.10	4.90	3.40	2.38	1.65	1.18	0.66
Read Noise (e-)	111.88	106.44	103.46	100.22	98.45	95.73	95.01	100.87
Full Well (ke-)	41.39	28.46	19.56	13.46	9.35	6.424	4.50	2.38
DR (dB)	51.3	48.5	45.5	42.5	39.5	36.5	33.5	27.4

Table 7 SWR5000KMB Camera performance parameters

Gain Value	100	141	199	282	398	562	794	1500
e-/ADU	10.44	7.16	4.92	3.42	2.35	1.64	1.14	0.53
Read Noise (e-)	115.65	111.15	107.79	105.44	101.89	99.56	95.78	82.89
Full Well (ke-)	41.53	28.44	19.48	13.50	9.23	6.39	4.37	1.94
DR (stop)	51.1	48.2	45.1	42.1	39.1	36.1	33.2	27.4

3.2 SWIR 400-1700 3MP 3.45um IMX993(5)

3.2.1 SWIR3000KMA

Table 8 SWIR3000KMA camera specifications

Model	SWIR3000KMA
Parameter	3.0M pixels 1/1.8" CMOS USB3 industrial camera
Camera	
Sensor model	Sony IMX993-AABA-C
Sensor Type	InGaAs
Spectral Range	400nm-1700nm
Pixel size	3.45 μm x 3.45 μm
Sensor size	1/1.8"
ADC	12 Bit / 8 Bit
Frame rate	8 Bit: 93fps@2048x1536、176fps@1024x768 12 Bit: 57fps@2048x1536、176fps@1024x768
Image Buffer	512MByte
Conversion Gain	10.3e/ADU (HCG) 17.29e/ADU (LCG)
Dynamic range	51.36dB (HCG) 51.47dB (LCG)
Readout Noise	111.88e (HCG) 186.61e (LCG)
Full Well	41.39ke (HCG) 69.92ke (LCG)
SNRmax	46.17dB (HCG) 48.45dB (LCG)
Sensitivity	TBD
Dark current	TBD
Gain range	1x-15x
Exposure time	15 μs -60sec
Shutter	Global shutter
Binning	Software2x2, 3x3, 4x4
Data interface	USB3
Digital I/O	One optical-coupling isolated input, one optical-coupling isolated output, two non-isolated input and output
Data Format	8bit / 12bit
Cooling performance	25°C below ambient temperature
Optical filter	400-1800nm(default); 1030-1800nm(optional)
CRA	2.35 Deg
General specification	
Power supply	Power with USB3.0 or 12V Power adapter
Power consumption	<2.1W(without cooling) / <25W(cooling)
Temperature	Working temperature -20~60°C, storage temperature -40~85°C
Humidity	20%-80%, no condensation
Size	80mm×80mm×45.5mm
Weight	<390g
Lens mount	C-mount
Software	ToupView/ SDK
Operating system	Win32/WinRT/Linux/macOS/Android
Certification	CE, FCC

3.2.2 SWIR3000KMA-10G

Table 9 SWIR3000KMA-10G camera specifications

Parameter	Model	SWIR3000KMA-10G 3.0M pixels 1/1.8" CMOS 10G industrial camera Camera
Sensor model		Sony IMX993-AABA-C
Sensor Type		InGaAs
Spectral Range		400nm-1700nm
Pixel size		3.45 μm x 3.45 μm
Sensor size		1/1.8"
ADC		12 Bit / 10 Bit / 8 Bit
Frame rate		8 Bit: 220fps@2048x1536、415fps@1024x768 10 Bit: 200fps@2048x1536、380fps@1024x768 12 Bit: 118fps@2048x1536、220fps@1024x768
Image Buffer		512MByte
Conversion Gain		10.3e/ADU (HCG) 17.29e/ADU (LCG)
Dynamic range		51.36dB (HCG) 51.47dB (LCG)
Readout Noise		111.88e (HCG) 186.61e (LCG)
Full Well		41.39ke (HCG) 69.92ke (LCG)
SNRmax		46.17dB (HCG) 48.45dB (LCG)
Sensitivity		TBD
Dark current		TBD
Gain range		1x-15x
Exposure time		15 μs -60sec
Shutter		Global shutter
Binning		Software2x2, 3x3, 4x4
Data interface		GigE
Digital I/O		One optical-coupling isolated input, one optical-coupling isolated output, two non-isolated input and output
Data Format		8bit / 12bit
Cooling performance		10°C below ambient temperature
Optical filter		400-1800nm(default); 1030-1800nm(optional)
CRA		2.35 Deg
General specification		
Power supply		12V Power adapter
Power consumption		TBD
Temperature		Working temperature -20~60°C, storage temperature -40~85°C
Humidity		20%-80%, no condensation
Size		80mm×80mm×45.5mm
Weight		<390g
Lens mount		C-mount
Software		ToupView/ SDK
Operating system		Win32/WinRT/Linux/macOS/Android
Certification		CE, FCC

3.2.3 SWIR3000KMA-CL150

Table 10 SWIR3000KMA-CL150 camera specifications

Parameter	Model
	SWIR3000KMA-CL150
	3.0M pixels 1/1.8" CMOS CameraLink industrial camera
	Camera
Sensor model	Sony IMX993-AABA-C
Sensor Type	InGaAs
Spectral Range	400nm-1700nm
Pixel size	3.45 μm x 3.45 μm
Sensor size	1/1.8"
ADC	12 Bit / 10 Bit
Frame rate	10 Bit: 150fps@2048x1536、300fps@1024x768 12 Bit: 93fps@2048x1536、176fps@1024x768
Image Buffer	512MByte
Conversion Gain	10.3e/ADU (HCG) 17.29e/ADU (LCG)
Dynamic range	51.36dB (HCG) 51.47dB (LCG)
Readout Noise	111.88e (HCG) 186.61e (LCG)
Full Well	41.39ke (HCG) 69.92ke (LCG)
SNRmax	46.17dB (HCG) 48.45dB (LCG)
Sensitivity	TBD
Dark current	TBD
Gain range	1x-15x
Exposure time	15 μs -60sec
Shutter	Global shutter
Binning	Software2x2, 3x3, 4x4
Data interface	GigE
Digital I/O	One optical-coupling isolated input, one optical-coupling isolated output, two non-isolated input and output
Data Format	8bit / 12bit
Cooling performance	10°C below ambient temperature
Optical filter	400-1800nm(default); 1030-1800nm(optional)
CRA	2.35 Deg
	General specification
Power supply	12V Power adapter
Power consumption	TBD
Temperature	Working temperature -20~60°C, storage temperature -40~85°C
Humidity	20%-80%, no condensation
Size	75mm×75mm×81.9mm
Weight	<390g
Lens mount	C-mount
Software	ToupView/ SDK
Operating system	Win32/WinRT/Linux/macOS/Android
Certification	CE, FCC

IMX992-AABA(TS) vs IMX990-AABA(MP)

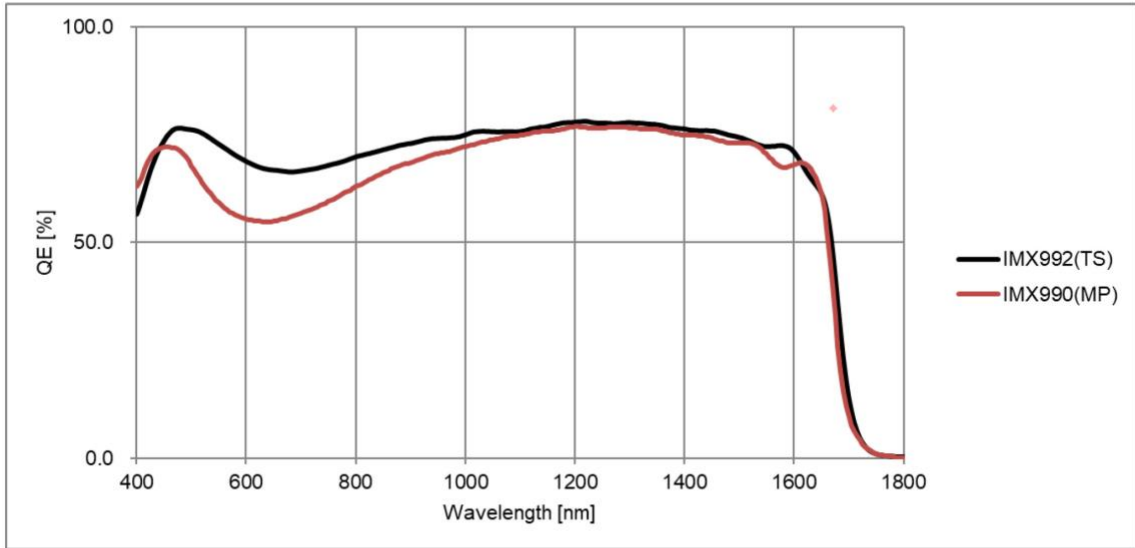

***NOTE**

- The data for B were measured at TS. It is possible to change at ES/MP.
- This data is reference for understanding of IMX992-AABA Quantum Efficiency characteristics. It is NOT guarantee of IMX992-AABA characteristics.
- Data acquisition conditions.
 - $T_j = 15^\circ\text{C}$
 - Characteristics in the package status
 - Constant photon number at each wavelength

Figure 2 SWIR5000KMA-G, SWIR5000KMB-G absolute quantum efficiency

3.2.4 SWIR3000KMB

Table 11 SWIR3000KMB camera specifications

Parameter	Model
	SWIR3000KMB 3.0M pixels 1/1.8" CMOS USB3 industrial camera Camera
Sensor model	Sony IMX993-AABJ-C
Sensor Type	InGaAs
Spectral Range	400nm-1700nm
Pixel size	3.45 μm x 3.45 μm
Sensor size	1/1.8"
ADC	12 Bit / 8 Bit
Frame rate	8 Bit: 93fps@2048x1536、176fps@1024x768 12 Bit: 57fps@2048x1536、176fps@1024x768
Image Buffer	512MByte
Conversion Gain	10.3e/ADU (HCG) 17.29e/ADU (LCG)
Dynamic range	51.36dB (HCG) 51.47dB (LCG)
Readout Noise	111.88e (HCG) 186.61e (LCG)
Full Well	41.39ke (HCG) 69.92ke (LCG)
SNRmax	46.17dB (HCG) 48.45dB (LCG)
Sensitivity	TBD
Dark current	TBD
Gain range	1x-15x
Exposure time	15 μs -60sec
Shutter	Global shutter
Binning	Software2x2, 3x3, 4x4
Data interface	USB3
Digital I/O	One optical-coupling isolated input, one optical-coupling isolated output, two non-isolated input and output
Data Format	8bit / 12bit
Cooling performance	10°C below ambient temperature
Optical filter	400-1800nm(default); 1030-1800nm(optional)
CRA	2.35 Deg
General specification	
Power supply	Power with USB3.0 or 12V Power adapter
Power consumption	<2.1W(without cooling) / <25W(cooling)
Temperature	Working temperature -20~60°C, storage temperature -40~85°C
Humidity	20%-80%, no condensation
Size	80mm×80mm×45.5mm
Weight	<390g
Lens mount	C-mount
Software	ToupView/ SDK
Operating system	Win32/WinRT/Linux/macOS/Android
Certification	CE, FCC

3.2.5 SWIR3000KMB-UMV

Table 12 SWIR3000KMB-UMV camera specifications

Model	SWIR3000KMB-UMV
Parameter	3.0M pixels 1/1.8" CMOS USB3 industrial camera
Camera	
Sensor model	Sony IMX993-AABJ-C
Sensor Type	InGaAs
Spectral Range	400nm-1700nm
Pixel size	3.45 μm x 3.45 μm
Sensor size	1/1.8"
ADC	12 Bit / 8 Bit
Frame rate	8 Bit: 93fps@2048x1536、176fps@1024x768 12 Bit: 57fps@2048x1536、176fps@1024x768
Image Buffer	512MByte
Conversion Gain	10.3e/ADU (HCG) 17.29e/ADU (LCG)
Dynamic range	51.36dB (HCG) 51.47dB (LCG)
Readout Noise	111.88e (HCG) 186.61e (LCG)
Full Well	41.39ke (HCG) 69.92ke (LCG)
SNRmax	46.17dB (HCG) 48.45dB (LCG)
Sensitivity	TBD
Dark current	TBD
Gain range	1x-15x
Exposure time	15 μs -60sec
Shutter	Global shutter
Binning	Software2x2, 3x3, 4x4
Data interface	USB3
Digital I/O	One optical-coupling isolated input, one optical-coupling isolated output, one non-isolated input and output
Data Format	8bit / 12bit
Optical filter	400-1800nm(default); 1030-1800nm(optional)
CRA	2.35 Deg
General specification	
Power supply	Power with USB3.0
Power consumption	<2.11W
Temperature	Working temperature -20~60 $^{\circ}\text{C}$, storage temperature -40~85 $^{\circ}\text{C}$
Humidity	20%-80%, no condensation
Size	33mm×33mm×38mm
Weight	70g
Lens mount	C-mount
Software	ToupView/ SDK
Operating system	Win32/WinRT/Linux/macOS/Android
Certification	CE, FCC

3.2.6 IMX993 QE Curve

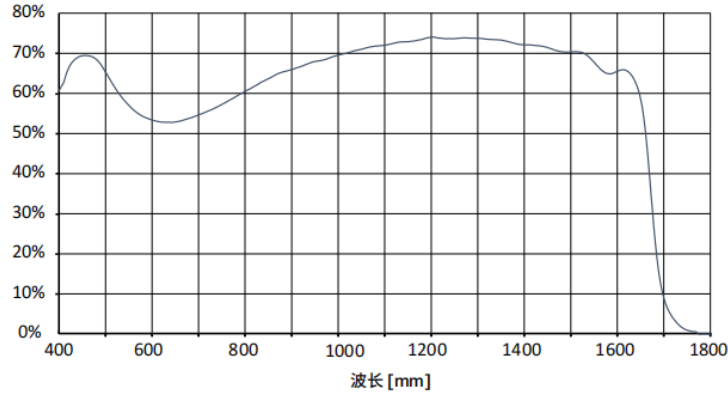

Figure 3 IM993 absolute quantum efficiency

3.2.7 IMX993 Camera performance parameters

The performance parameters of the camera are as follows:

- Maximum Resolution
- RAW 12 Bit mode
- Temperature: 5°C
- HCG

Table 13 SWR3000KMA Camera performance parameters

Gain Value	100	141	199	282	398	562	794	1500
e-/ADU	10.30	7.10	4.90	3.40	2.38	1.65	1.18	0.66
Read Noise (e-)	111.88	106.44	103.46	100.22	98.45	95.73	95.01	100.87
Full Well (ke-)	41.39	28.46	19.56	13.46	9.35	6.424	4.50	2.38
DR (dB)	51.3	48.5	45.5	42.5	39.5	36.5	33.5	27.4

Table 14 SWR3000KMB Camera performance parameters

Gain Value	100	141	199	282	398	562	794	1500
e-/ADU	10.48	7.13	4.92	3.38	2.34	1.64	1.11	0.33
Read Noise (e-)	123.05	116.96	114.17	110.19	105.91	102.38	94.43	49.93
Full Well (ke-)	41.80	28.44	19.56	13.44	9.28	6.46	4.37	1.27
DR (stop)	50.6	47.7	44.7	41.7	38.8	36.0	33.3	28.1

3.3 SWIR 400-1700 1.3MP 5um IMX990(6)

3.3.1 SWIR1300KMA

Table 15 SWIR1300KMA camera specifications

Parameter	Model	SWIR1300KMA
		1.31M pixels 1/2" CMOS USB3 industrial camera
Camera		
Sensor model		Sony IMX990-AABA-C
Sensor Type		InGaAs
Spectral Range		400nm-1700nm
Pixel size		5.0 μm x 5.0 μm
Sensor size		1/2"
ADC		12 Bit / 8 Bit
Frame rate		8 Bit: 200fps@1280 x 1024、392fps@640 x 512 12 Bit: 108fps@1280 x 1024、209fps@640 x 512
Image Buffer		512MByte
Conversion Gain		44.3e/ADU
Dynamic range		58.7dB
Readout Noise		211e
Full Well		181.6ke
SNRmax		52.6dB
Sensitivity		121mV
Dark current		383e/s(0°C) 510e/s(10°C) 638e/s(20°C)
Gain range		1x-15x
Exposure time		15μs-60sec
Shutter		Global shutter
Binning		Software2x2, 3x3, 4x4
Data interface		USB3
Digital I/O		One optical-coupling isolated input, one optical-coupling isolated output, two non-isolated input and output
Data Format		8bit / 12bit
Cooling performance		25°C below ambient temperature
Optical filter		400-1800nm(default); 1030-1800nm(optional)
CRA		2.35 Deg
General specification		
Power supply		Power with USB3.0 or 12V Power adapter
Power consumption		<2.1W(without cooling) / <25W(cooling)
Temperature		Working temperature -20~60°C, storage temperature -40~85°C
Humidity		20%-80%, no condensation
Size		80mm×80mm×45.5mm
Weight		<390g
Lens mount		C-mount
Software		ToupView/ SDK
Operating system		Win32/WinRT/Linux/macOS/Android
Certification		CE, FCC

3.3.2 SWIR1300KMA-G

Table 16 SWIR1300KMA-G camera specifications

Parameter	Model
	SWIR1300KMA-G 1.31M pixels 1/2" CMOS GigE industrial camera Camera
Sensor model	Sony IMX990-AABA-C
Sensor Type	InGaAs
Spectral Range	400nm-1700nm
Pixel size	5.0 μm x 5.0 μm
Sensor size	1/2"
ADC	12 Bit / 8 Bit
Frame rate	8 Bit: 90fps@1280 x 1024、253fps@640 x 512 12 Bit: 45fps@1280 x 1024、135fps@640 x 512
Image Buffer	512MByte
Conversion Gain	44.3e/ADU
Dynamic range	58.7dB
Readout Noise	211e
Full Well	181.6ke
SNRmax	52.6dB
Sensitivity	121mV
Dark current	383e/s(0°C) 510e/s(10°C) 638e/s(20°C)
Gain range	1x-15x
Exposure time	15μs-60sec
Shutter	Global shutter
Binning	Software2x2, 3x3, 4x4
Data interface	GigE
Digital I/O	One optical-coupling isolated input, one optical-coupling isolated output, two non-isolated input and output
Data Format	8bit / 12bit
Cooling performance	25°C below ambient temperature
Optical filter	400-1800nm(default); 1030-1800nm(optional)
CRA	2.35 Deg
General specification	
Power supply	12V Power adapter
Power consumption	<2.1W(without cooling) / <25W(cooling)
Temperature	Working temperature -20~60°C, storage temperature -40~85°C
Humidity	20%-80%, no condensation
Size	80mm×80mm×45.5mm
Weight	<390g
Lens mount	C-mount
Software	ToupView/ SDK
Operating system	Win32/WinRT/Linux/macOS/Android
Certification	CE, FCC

3.3.3 SWIR1300KMA-CL200

Table 17 SWIR1300KMA-CL200 camera specifications

Parameter	Model
	SWIR1300KMA-CL200 1.31M pixels 1/2" CMOS CameraLink industrial camera Camera
Sensor model	Sony IMX990-AABA-C
Sensor Type	InGaAs
Spectral Range	400nm-1700nm
Pixel size	5.0 μm x 5.0 μm
Sensor size	1/2"
ADC	12 Bit / 8 Bit
Frame rate	8 Bit: 200fps@1280 x 1024、392fps@640 x 512 12 Bit: 108fps@1280 x 1024、209fps@640 x 512
Image Buffer	512MByte
Conversion Gain	44.3e/ADU
Dynamic range	58.7dB
Readout Noise	211e
Full Well	181.6ke
SNRmax	52.6dB
Sensitivity	121mV
Dark current	383e/s(0°C) 510e/s(10°C) 638e/s(20°C)
Gain range	1x-15x
Exposure time	15μs-60sec
Shutter	Global shutter
Binning	Nonsupport
Data interface	CameraLink
Digital I/O	One optical-coupling isolated input, one optical-coupling isolated output, two non-isolated input and output
Data Format	8bit / 12bit
Cooling performance	25°C below ambient temperature
Optical filter	400-1800nm(default); 1030-1800nm(optional)
CRA	2.35 Deg
General specification	
Power supply	12V Power adapter
Power consumption	<2.1W(without cooling) / <25W(cooling)
Temperature	Working temperature -20~60°C, storage temperature -40~85°C
Humidity	20%-80%, no condensation
Size	80mm×80mm×45.5mm
Weight	<390g
Lens mount	C-mount
Software	ToupView/ SDK
Operating system	Win32/WinRT/Linux/macOS/Android
Certification	CE, FCC

3.3.4 SWIR1300KMB

Table 18 SWIR1300KMB camera specifications

Model	SWIR1300KMB
Parameter	1.3M pixels 1/2" CMOS USB3 industrial camera Camera
Sensor model	Sony IMX990-AABJ-C
Sensor Type	InGaAs
Spectral Range	400nm-1700nm
Pixel size	5.0 μm x 5.0 μm
Sensor size	1/2"
ADC	12 Bit / 8 Bit
Frame rate	8 Bit: 200fps@1280 x 1024、392fps@640 x 512 12 Bit: 108fps@1280 x 1024、209fps@640 x 512
Image Buffer	512MByte
Conversion Gain	42.8e/ADU
Dynamic range	58.7dB
Readout Noise	197.6e
Full Well	175.4ke
SNRmax	52.4dB
Sensitivity	121mV
Dark current	638e/s(20°C)
Gain range	1x-15x
Exposure time	15μs-60sec
Shutter	Global shutter
Binning	Software2x2, 3x3, 4x4
Data interface	USB3
Digital I/O	One optical-coupling isolated input, one optical-coupling isolated output, two non-isolated input and output
Data Format	8bit / 12bit
Cooling performance	10°C below ambient temperature
Optical filter	400-1800nm(default); 1030-1800nm(optional)
CRA	2.35 Deg
General specification	
Power supply	Power with USB3.0 or 12V Power adapter
Power consumption	<2.1W(without cooling) / <25W(cooling)
Temperature	Working temperature -20~60°C, storage temperature -40~85°C
Humidity	20%-80%, no condensation
Size	80mm×80mm×45.5mm
Weight	<390g
Lens mount	C-mount
Software	ToupView/ SDK
Operating system	Win32/WinRT/Linux/macOS/Android
Certification	CE, FCC

3.3.5 SWIR1300KMB-G

Table 19 SWIR1300KMB-G camera specifications

Parameter	Model
SWIR1300KMB-G	
1.3M pixels 1/2" CMOS GigE industrial camera	
Camera	
Sensor model	Sony IMX990-AABJ-C
Sensor Type	InGaAs
Spectral Range	400nm-1700nm
Pixel size	5.0 μm x 5.0 μm
Sensor size	1/2"
ADC	12 Bit / 8 Bit
Frame rate	8 Bit: 90fps@1280 x 1024、253fps@640 x 512 12 Bit: 45fps@1280 x 1024、135fps@640 x 512
Image Buffer	512MByte
Conversion Gain	42.8e/ADU
Dynamic range	58.7dB
Readout Noise	197.6e
Full Well	175.4ke
SNRmax	52.4dB
Sensitivity	121mV
Dark current	638e/s(20°C)
Gain range	1x-15x
Exposure time	15 μs -60sec
Shutter	Global shutter
Binning	Software2x2, 3x3, 4x4
Data interface	GigE
Digital I/O	One optical-coupling isolated input, one optical-coupling isolated output, two non-isolated input and output
Data Format	8bit / 12bit
Cooling performance	10°C below ambient temperature
Optical filter	400-1800nm(default); 1030-1800nm(optional)
CRA	2.35 Deg
General specification	
Power supply	12V Power adapter
Power consumption	<2.1W(without cooling) / <25W(cooling)
Temperature	Working temperature -20~60°C, storage temperature -40~85°C
Humidity	20%-80%, no condensation
Size	80mm×80mm×45.5mm
Weight	<390g
Lens mount	C-mount
Software	ToupView/ SDK
Operating system	Win32/WinRT/Linux/macOS/Android
Certification	CE, FCC

3.3.6 SWIR1300KMB-UMV

Table 20 SWIR1300KMB-UMV camera specifications

Parameter	Model	SWIR1300KMB-UMV 1.3M pixels 1/2" CMOS USB3 industrial camera Camera
Sensor model		Sony IMX990-AABJ-C
Sensor Type		InGaAs
Spectral Range		400nm-1700nm
Pixel size		5.0 μm x 5.0 μm
Sensor size		1/2"
ADC		12 Bit / 8 Bit
Frame rate		8 Bit: 223fps@1280 x 1024, 428fps@640 x 512 12 Bit: 118.7fps@1280 x 1024, 227.7fps@640 x 512
Image Buffer		512MByte
Conversion Gain		42.8e/ADU
Dynamic range		58.7dB
Readout Noise		197.6e
Full Well		175.4ke
SNRmax		52.4dB
Sensitivity		121mV
Dark current		638e/s(20°C)
Gain range		1x-15x
Exposure time		15μs-60sec
Shutter		Global shutter
Binning		Software2x2, 3x3, 4x4
Data interface		USB3
Digital I/O		One optical-coupling isolated input, one optical-coupling isolated output, one non-isolated input and output
Data Format		8bit / 12bit
Cooling performance		10°C below ambient temperature
Optical filter		400-1800nm(default); 1030-1800nm(optional)
CRA		2.35 Deg
General specification		
Power supply		Power with USB3.0
Power consumption		<2.11W
Temperature		Working temperature -20~60°C, storage temperature -40~85°C
Humidity		20%-80%, no condensation
Size		33mm×33mm×38mm
Weight		70g
Lens mount		C-mount
Software		ToupView/ SDK
Operating system		Win32/WinRT/Linux/macOS/Android
Certification		CE, FCC

When the ambient temperature is 25.5 degrees, the camera is placed on a wooden table, and the exposure time is 1.5ms in 8bit mode.

Resolution	Overclock	Frame rate	Power consumption	Sensor temperature
1280*1024	Off	135fps	1.75W	42.3
1280*1024	On	223fps	2.11W	43.2
640*512	Off	258fps	1.51W	38.1
640*512	On	428fps	1.75W	40

3.3.7 IMX990 QE Curve

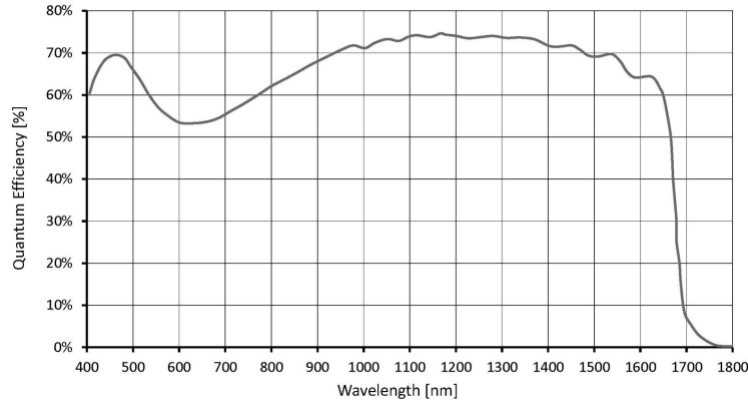

Figure 4 IM990 absolute quantum efficiency

3.3.8 IMX990 Camera performance parameters

The performance parameters of the camera are as follows:

- Maximum Resolution
- RAW 12 Bit mode
- Temperature: 5°C
- HCG

Table 21 SWR1300KMA Camera performance parameters

Gain Value	100	125	158	199	251	316	398	501	603	794	1000	1258	1500
Rel Gain (dB)	0.00	1.91	3.93	5.94	7.94	9.96	11.99	14.05	16.07	18.10	20.15	22.07	23.70
e-/ADU	44.32	35.56	28.21	22.37	17.76	14.08	11.15	8.79	6.97	5.52	4.36	3.49	2.90
Read Noise (e-)	210.89	209.29	209.71	208.16	207.64	205.12	203.76	202.01	199.78	197.93	198.65	198.47	198.65
Full Well (ke-)	181.55	145.64	115.53	91.64	72.76	57.68	45.68	36.02	28.55	22.60	17.85	14.30	11.86
DR (stop)	9.75	9.44	9.11	8.78	8.45	8.14	7.81	7.48	7.16	6.84	6.49	6.17	5.90

Table 22 SWR1300KMB Camera performance parameters

Gain Value	100	125	158	199	251	316	398	501	603	794	1000	1258	1500
Rel Gain (dB)	0.00	1.25	1.57	1.97	2.47	3.12	3.91	4.92	6.20	7.77	9.72	11.94	14.32
e-/ADU	42.82	34.37	27.32	21.75	17.31	13.73	10.95	8.71	6.91	5.51	4.40	3.59	2.99
Read Noise (e-)	197.63	196.91	195.76	198.17	195.23	195.78	195.14	196.15	193.04	195.82	203.27	208.32	208.36
Full Well (ke-)	175.41	140.77	111.90	89.07	70.90	56.25	44.84	35.67	28.30	22.57	18.04	14.69	12.25
DR (stop)	9.79	9.48	9.16	8.81	8.50	8.17	7.84	7.51	7.20	6.85	6.47	6.14	5.88

3.4 SWIR 400-1700 0.33MP 5um IMX991(6)

3.4.1 SWIR330KMA

Table 23 SWIR330KMA camera specifications

Model	SWIR330KMA
Parameter	0.33M pixels 1/4" CMOS USB3 industrial camera
Camera	
Sensor model	Sony IMX991-AABA-C
Sensor Type	InGaAs
Spectral Range	400nm-1700nm
Pixel size	5.0 μm x 5.0 μm
Sensor size	1/4"
ADC	12 Bit / 8 Bit
Frame rate	8 Bit: 400fps@640 x 512、753fps@320 x 256 12 Bit: 212fps@640 x 512、400fps@320 x 256
Image Buffer	512MByte
Conversion Gain	42.29e/ADU
Dynamic range	59.7dB
Readout Noise	176.7e
Full Well	173.23ke
SNRmax	52.39dB
Sensitivity	121mV
Dark current	383e/s(0°C) 510e/s(10°C) 638e/s(20°C)
Gain range	1x-15x
Exposure time	15μs-60sec
Shutter	Global shutter
Binning	Software2x2, 3x3, 4x4
Data interface	USB3
Digital I/O	One optical-coupling isolated input, one optical-coupling isolated output, two non-isolated input and output
Data Format	8bit / 12bit
Cooling performance	25°C below ambient temperature
Optical filter	400-1800nm(default); 1030-1800nm(optional)
CRA	2.35 Deg
General specification	
Power supply	Power with USB3.0 or 12V Power adapter
Power consumption	<2.1W(without cooling) / <25W(cooling)
Temperature	Working temperature -20~60°C, storage temperature -40~85°C
Humidity	20%-80%, no condensation
Size	80mm×80mm×45.5mm
Weight	<390g
Lens mount	C-mount
Software	ToupView/ SDK
Operating system	Win32/WinRT/Linux/macOS/Android
Certification	CE, FCC

3.4.2 SWIR330KMA-G

Table 24 SWIR330KMA-G camera specifications

Parameter	Model	SWIR330KMA-G 0.33M pixels 1/4" CMOS GigE industrial camera Camera
Sensor model		Sony IMX991-AABA-C
Sensor Type		InGaAs
Spectral Range		400nm-1700nm
Pixel size		5.0 μm x 5.0 μm
Sensor size		1/4"
ADC		12 Bit / 8 Bit
Frame rate		8 Bit: 257.8fps@640 x 512、486.1fps@320 x 256 12 Bit: 137.1fps@640 x 512、258.6fps@320 x 256
Image Buffer		512MByte
Conversion Gain		42.29e/ADU
Dynamic range		59.7dB
Readout Noise		176.7e
Full Well		173.23ke
SNRmax		52.39dB
Sensitivity		121mV
Dark current		383e/s(0°C) 510e/s(10°C) 638e/s(20°C)
Gain range		1x-15x
Exposure time		15 μs -60sec
Shutter		Global shutter
Binning		Software2x2, 3x3, 4x4
Data interface		GigE
Digital I/O		One optical-coupling isolated input, one optical-coupling isolated output, two non-isolated input and output
Data Format		8bit / 12bit
Cooling performance		25°C below ambient temperature
Optical filter		400-1800nm(default); 1030-1800nm(optional)
CRA		2.35 Deg
General specification		
Power supply		12V Power adapter
Power consumption		<2.1W(without cooling) / <25W(cooling)
Temperature		Working temperature -20~60°C, storage temperature -40~85°C
Humidity		20%-80%, no condensation
Size		80mm×80mm×45.5mm
Weight		<390g
Lens mount		C-mount
Software		ToupView/ SDK
Operating system		Win32/WinRT/Linux/macOS/Android
Certification		CE, FCC

3.4.3 SWIR330KMA-CL400

Table 25 SWIR330KMA-CL400 camera specifications

Parameter	Model
	SWIR330KMA- CL400 0.33M pixels 1/4" CMOS CameraLink industrial camera Camera
Sensor model	Sony IMX991-AABA-C
Sensor Type	InGaAs
Spectral Range	400nm-1700nm
Pixel size	5.0 μm x 5.0 μm
Sensor size	1/4"
ADC	12 Bit / 8 Bit
Frame rate	8 Bit: 400fps@640 x 512、753fps@320 x 256 12 Bit: 212fps@640 x 512、400fps@320 x 256
Image Buffer	512MByte
Conversion Gain	42.29e/ADU
Dynamic range	59.7dB
Readout Noise	176.7e
Full Well	173.23ke
SNRmax	52.39dB
Sensitivity	121mV
Dark current	383e/s(0°C) 510e/s(10°C) 638e/s(20°C)
Gain range	1x-15x
Exposure time	15μs-60sec
Shutter	Global shutter
Binning	Software2x2, 3x3, 4x4
Data interface	Nonsupport
Digital I/O	One optical-coupling isolated input, one optical-coupling isolated output, two non-isolated input and output
Data Format	8bit / 12bit
Cooling performance	25°C below ambient temperature
Optical filter	400-1800nm(default); 1030-1800nm(optional)
CRA	2.35 Deg
General specification	
Power supply	12V Power adapter
Power consumption	<2.1W(without cooling) / <25W(cooling)
Temperature	Working temperature -20~60°C, storage temperature -40~85°C
Humidity	20%-80%, no condensation
Size	75mm×75mm×81.9mm
Weight	<390g
Lens mount	C-mount
Software	ToupView/ SDK
Operating system	Win32/WinRT/Linux/macOS/Android
Certification	CE, FCC

3.4.4 SWIR330KMB

Table 26 SWIR330KMB camera specifications

Parameter	Model
	SWIR330KMB 0.33M pixels 1/4" CMOS USB3 industrial camera Camera
Sensor model	Sony IMX991-AABJ-C
Sensor Type	InGaAs
Spectral Range	400nm-1700nm
Pixel size	5.0 μm x 5.0 μm
Sensor size	1/4"
ADC	12 Bit / 8 Bit
Frame rate	8 Bit: 400fps@640 x 512、753fps@320 x 256 12 Bit: 212fps@640 x 512、400fps@320 x 256
Image Buffer	512MByte
Conversion Gain	43.0e/ADU
Dynamic range	59.6dB
Readout Noise	178.8e
Full Well	176.2ke
SNRmax	52.5dB
Sensitivity	121mV
Dark current	638e/s(20°C)
Gain range	1x-15x
Exposure time	15μs-60sec
Shutter	Global shutter
Binning	Software2x2, 3x3, 4x4
Data interface	USB3
Digital I/O	One optical-coupling isolated input, one optical-coupling isolated output, two non-isolated input and output
Data Format	8bit / 12bit
Cooling performance	10°C below ambient temperature
Optical filter	400-1800nm(default); 1030-1800nm(optional)
CRA	2.35 Deg
General specification	
Power supply	Power with USB3.0 or 12V Power adapter
Power consumption	<2.1W(without cooling) / <25W(cooling)
Temperature	Working temperature -20~60°C, storage temperature -40~85°C
Humidity	20%-80%, no condensation
Size	80mm×80mm×45.5mm
Weight	<390g
Lens mount	C-mount
Software	ToupView/ SDK
Operating system	Win32/WinRT/Linux/macOS/Android
Certification	CE, FCC

3.4.5 SWIR330KMB-G

Table 27 SWIR330KMB-G camera specifications

Parameter	Model
SWIR330KMB-G	
0.33M pixels 1/4" CMOS GigE industrial camera	
Camera	
Sensor model	Sony IMX991-AABJ-C
Sensor Type	InGaAs
Spectral Range	400nm-1700nm
Pixel size	5.0 μm x 5.0 μm
Sensor size	1/4"
ADC	12 Bit / 8 Bit
Frame rate	8 Bit: 257.8fps@640 x 512、486.1fps@320 x 256 12 Bit: 137.1fps@640 x 512、258.6fps@320 x 256
Image Buffer	512MByte
Conversion Gain	43.0e/ADU
Dynamic range	59.6dB
Readout Noise	178.8e
Full Well	176.2ke
SNRmax	52.5dB
Sensitivity	121mV
Dark current	638e/s(20°C)
Gain range	1x-15x
Exposure time	15μs-60sec
Shutter	Global shutter
Binning	Software2x2, 3x3, 4x4
Data interface	GigE
Digital I/O	One optical-coupling isolated input, one optical-coupling isolated output, two non-isolated input and output
Data Format	8bit / 12bit
Cooling performance	10°C below ambient temperature
Optical filter	400-1800nm(default); 1030-1800nm(optional)
CRA	2.35 Deg
General specification	
Power supply	12V Power adapter
Power consumption	<2.1W(without cooling) / <25W(cooling)
Temperature	Working temperature -20~60°C, storage temperature -40~85°C
Humidity	20%-80%, no condensation
Size	80mm×80mm×45.5mm
Weight	<390g
Lens mount	C-mount
Software	ToupView/ SDK
Operating system	Win32/WinRT/Linux/macOS/Android
Certification	CE, FCC

3.4.6 SWIR330KMB-UMV

Table 28 SWIR330KMB-UMV camera specifications

Model	SWIR330KMB-UMV
Parameter	0.33M pixels 1/4" CMOS USB3 industrial camera
	Camera
Sensor model	Sony IMX991-AABJ-C
Sensor Type	InGaAs
Spectral Range	400nm-1700nm
Pixel size	5.0 μm x 5.0 μm
Sensor size	1/4"
ADC	12 Bit / 8 Bit
Frame rate	8 Bit: 428.1fps@640 x 512、807fps@320 x 256 12 Bit: 227.7fps@640 x 512、429.3fps@320 x 256
Image Buffer	512MByte
Conversion Gain	43.0e/ADU
Dynamic range	59.6dB
Readout Noise	178.8e
Full Well	176.2ke
SNRmax	52.5dB
Sensitivity	121mV
Dark current	638e/s(20°C)
Gain range	1x-15x
Exposure time	15μs-60sec
Shutter	Global shutter
Binning	Software2x2, 3x3, 4x4
Data interface	USB3.0
Digital I/O	One optical-coupling isolated input, one optical-coupling isolated output, one non-isolated input and output
Data Format	8bit / 12bit
Optical filter	400-1800nm(default); 1030-1800nm(optional)
CRA	2.35 Deg
	General specification
Power supply	Power with USB3.0
Power consumption	<2.11W
Temperature	Working temperature -20~60°C, storage temperature -40~85°C
Humidity	20%-80%, no condensation
Size	33mm×33mm×38mm
Weight	70g
Lens mount	C-mount
Software	ToupView/ SDK
Operating system	Win32/WinRT/Linux/macOS/Android
Certification	CE, FCC

3.4.7 IMX991 QE Curve

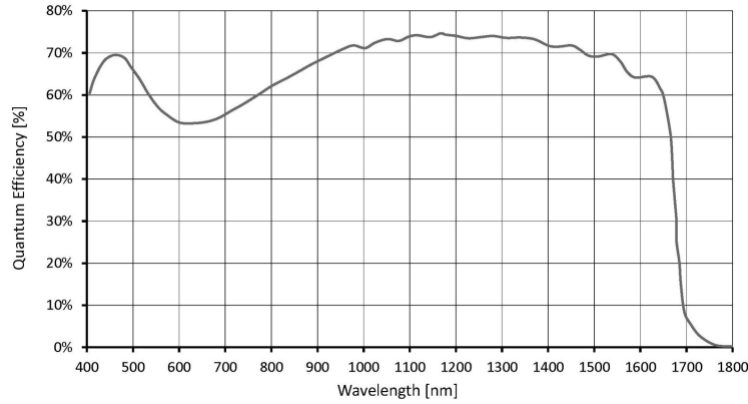

Figure 5 IM991 absolute quantum efficiency

3.4.8 IMX991 Camera performance parameters

The performance parameters of the camera are as follows:

- Maximum Resolution
- RAW 12 Bit mode
- Temperature: 5°C
- HCG

Table 29 SWR1300KMA Camera performance parameters

Gain Value	100	125	158	199	251	316	398	501	603	794	1000	1258	1500
Rel Gain (dB)	0.00	1.89	3.91	5.88	7.88	9.89	11.88	13.87	15.85	17.84	19.82	21.66	23.23
e-/ADU	42.29	34.00	26.98	21.48	17.07	13.54	10.77	8.57	6.82	5.43	4.32	3.49	2.92
Read Noise (e-)	174.99	169.28	172.01	171.45	170.73	169.36	168.80	170.65	173.33	176.87	184.04	189.99	187.34
Full Well (ke-)	173.23	139.27	110.49	87.99	69.90	55.47	44.11	35.08	27.92	22.23	17.69	14.31	11.95
DR (stop)	9.95	9.68	9.33	9.00	8.68	8.36	8.03	7.68	7.33	6.97	6.59	6.24	6.00

Table 30 SWR1300KMB Camera performance parameters

Gain Value	100	125	158	199	251	316	398	501	603	794	1000	1258	1500
Rel Gain (dB)	0.00	1.90	3.90	5.91	7.91	9.93	11.92	13.93	15.92	17.90	19.94	21.70	23.21
e-/ADU	43.01	34.57	27.45	21.79	17.30	13.72	10.91	8.65	6.88	5.48	4.33	3.54	2.97
Read Noise (e-)	178.78	178.53	179.35	178.94	178.17	174.61	174.78	172.38	176.29	181.30	186.37	196.79	197.80
Full Well (ke-)	176.17	141.60	112.42	89.26	70.86	56.18	44.67	35.44	28.18	22.43	17.74	14.49	12.18
DR (stop)	9.94	9.63	9.29	8.96	8.64	8.33	8.00	7.68	7.32	6.95	6.57	6.20	5.94

4 SWIR 900-1700 camera model specifications

4.1 SWIR 900-1700 1.3MP 15um(4)

4.1.1 SWIR1302KMB-U200

Table 31 SWIR1302KMB-U200 camera specifications

Parameter	Model	SWIR1302KMB-U200
		1.3M pixels 1.5" InGaAs USB industrial camera
		Camera
Sensor model		China produced 1280x1024
Sensor Type		InGaAs CMOS
Spectral Range		900nm-1700nm
Pixel size		15 μm x 15 μm
Sensor size		1.5"
ADC		14 Bit
Frame rate		200fps@1280x1024
Image Buffer		512MByte
QE		≥70@1.55μm
Conversion Gain		1μV/e- (LG), 16μV/e- (MG), 53.3μV/e- (HG)
Dynamic range		70.59dB(LG), 67.96dB(MG), 47.98dB(HG) *1 (Only reference)
Readout Noise		586.82e(LG), 35.05e(MG), 68.44e(HG) (Only reference)
Full Well		1.9Me- (LG), 118.75Ke- (MG), 33.75Ke-(HG) *1
SNRmax		62.98dB(LG), 49.43dB(MG), 42.34dB(HG) (Only reference)
Dark current		30fa@0.1V&18°C (Only reference)
Exposure time		16μs-1sec
Shutter		Global shutter
Data interface		USB3
Digital I/O		One optical-coupling isolated input, one optical-coupling isolated output, two non-isolated input and output
Data Format		Mono 8 / Mono 14 / Packet12
Cooling performance		40°C below ambient temperature
		General specification
Power supply		12V Power adapter
Power consumption		8.4W(TEC OFF)/ <16W(TEC ON)
Temperature		Working temperature -30~60°C, storage temperature -40~85°C
Humidity		20%-80%, no condensation
Size		68mm×68mm×89.8mm
Weight		485g
Lens mount		M42
Software		ToupView/ SDK

*1: LG: CDS-OFF, DeNoise-ON; MG: CDS-ON, DeNoise-OFF; HG: CDS-ON, DeNoise-OFF.

4.1.2 SWIR1302KMB-10G

Table 32 SWIR1302KMB-10G camera specifications

Parameter	Model	SWIR1302KMB-10G 1.3M pixels 1.5" InGaAs 10G industrial camera Camera
Sensor model		China produced 1280x1024
Sensor Type		InGaAs CMOS
Spectral Range		900nm-1700nm
Pixel size		15 μm x 15 μm
Sensor size		1.5"
ADC		14 Bit
Frame rate		200fps@1280x1024
Image Buffer		512MByte
QE		≥70@1.55μm
Conversion Gain		1μV/e- (LG), 16μV/e- (MG), 53.3μV/e- (HG)
Dynamic range		69.2dB(LG), 63.2dB(MG), 57.4dB(HG) *1 (Only reference)
Readout Noise		1.3DN(LG), 2.7DN(MG), 5.0DN(HG) (Only reference)
Full Well		1.9Me- (LG), 118.75Ke- (MG), 33.75Ke- (HG) *1
SNRmax		65.4dB(LG), 48.5dB(MG), 40.7dB(HG) (Only reference)
Dark current		30fa@0.1V&18°C (Only reference)
Exposure time		25μs-5sec
Shutter		Global shutter
Data interface		10GigE
Digital I/O		One optical-coupling isolated input, one optical-coupling isolated output, two non-isolated input and output
Data Format		Mono 8 / Mono 14
Cooling performance		40°C below ambient temperature
General specification		
Power supply		12V Power adapter
Power consumption		8.4W(TEC OFF)/ <16W(TEC ON)
Temperature		Working temperature -30~60°C, storage temperature -40~85°C
Humidity		20%-80%, no condensation
Size		68mm×68mm×89.8mm
Weight		485g
Lens mount		M42
Software		ToupView/ SDK

*1: LG: CDS-OFF, DeNoise-ON; MG: CDS-ON, DeNoise-OFF; HG: CDS-ON, DeNoise-OFF.

4.1.3 SWIR1302KMA-CL200 China Produced

Table 33 SWIR1302KMA-CL200 camera specifications

Parameter	Model
SWIR1302KMA-CL200	
1.3M pixels 1.5" InGaAs CameraLink industrial camera	
Camera	
Sensor model	China produced 1280x1024
Sensor Type	InGaAs CMOS
Spectral Range	900nm-1700nm
Pixel size	15 μm x 15 μm
Sensor size	1.5"
ADC	14 Bit
Frame rate	200fps@1280x1024
Image Buffer	512MByte
QE	$\geq 70@1.55\mu\text{m}$
Conversion Gain	1 $\mu\text{V}/\text{e}^-$ (LG), 16 $\mu\text{V}/\text{e}^-$ (MG), 53.3 $\mu\text{V}/\text{e}^-$ (HG)
Dynamic range	69.2dB(LG), 63.2dB(MG), 57.4dB(HG) *1 (Only reference)
Readout Noise	1.3DN(LG), 2.7DN(MG), 5.0DN(HG) (Only reference)
Full Well	1.9Me $^-$ (LG), 118.75Ke $^-$ (MG), 33.75Ke $^-$ (HG) *1
SNRmax	65.4dB(LG), 48.5dB(MG), 40.7dB(HG) (Only reference)
Dark current	30fa@0.1V&18°C (Only reference)
Exposure time	16 μs -1sec
Shutter	Global shutter
Data interface	CameraLink Full
Digital I/O	One optical-coupling isolated input, one optical-coupling isolated output
Data Format	Mono 14
Cooling performance	40°C below ambient temperature
Camera type	Nationally produced devices
General specification	
Power supply	12V Power adapter
Power consumption	8.4W(TEC OFF)/ <16W(TEC ON)
Temperature	Working temperature -30~60°C, storage temperature -40~85°C
Humidity	20%-80%, no condensation
Size	68mm×68mm×89.8mm
Weight	485g
Lens mount	M42
Software	Provide SDK development kit and CL View software based on Delsa acquisition card

*1: LG: CDS-OFF, DeNoise-ON; MG: CDS-ON, DeNoise-OFF; HG: CDS-ON, DeNoise-OFF.

4.1.4 SWIR1302KMB-CL200

Table 34 SWIR1302KMB-CL200 camera specifications

Parameter	Model	SWIR1302KMB-CL200 1.3M pixels 1.5" InGaAs CameraLink industrial camera Camera
Sensor model		China produced 1280x1024
Sensor Type		InGaAs CMOS
Spectral Range		900nm-1700nm
Pixel size		15 μm x 15 μm
Sensor size		1.5"
ADC		14 Bit
Frame rate		200fps@1280x1024
Image Buffer		512MByte
QE		≥70@1.55μm
Conversion Gain		1μV/e- (LG), 16μV/e- (MG), 53.3μV/e- (HG)
Dynamic range		69.2dB(LG), 63.2dB(MG), 57.4dB(HG) *1 (Only reference)
Readout Noise		1.3DN(LG), 2.7DN(MG), 5.0DN(HG) (Only reference)
Full Well		1.9Me- (LG), 118.75Ke- (MG), 33.75Ke- (HG) *1
SNRmax		65.4dB(LG), 48.5dB(MG), 40.7dB(HG) (Only reference)
Dark current		30fa@0.1V&18°C (Only reference)
Exposure time		16μs-1sec
Shutter		Global shutter
Data interface		CameraLink Full
Digital I/O		One optical-coupling isolated input, one optical-coupling isolated output
Data Format		Mono 14
Cooling performance		40°C below ambient temperature
Camera type		High performance
General specification		
Power supply		12V Power adapter
Power consumption		8.4W(TEC OFF)/ <16W(TEC ON)
Temperature		Working temperature -30~60°C, storage temperature -40~85°C
Humidity		20%-80%, no condensation
Size		68mm×68mm×89.8mm
Weight		485g
Lens mount		M42
Software		Provide SDK development kit and CL View software based on Delsa acquisition card

*1: LG: CDS-OFF, DeNoise-ON; MG: CDS-ON, DeNoise-OFF; HG: CDS-ON, DeNoise-OFF.

4.1.5 SWIR1302 QE Curve

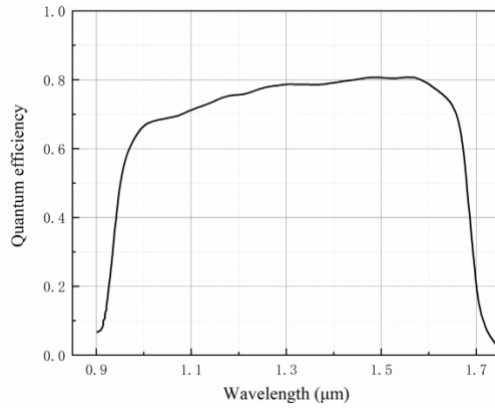

Figure 6 SWIR1302 QE Curve

4.1.6 SWIR1302 Frame rate and ROI frame rate

The camera support hardware ROI, the smaller the ROI size, the faster the frame rate

Table 35 CL120 ROI typical frame rate

X Size	Y Size	FPS
1280	1024	207
1280	512	413
640	512	693
320	256	2057
200	200	3206

Table 36 U120 ROI typical frame rate

X Size	Y Size	FPS
1280	1024	207
1280	512	413
640	512	693
320	256	2057
200	200	3206

Table 37 10G ROI typical frame rate

X Size	Y Size	FPS
1280	1024	207
1280	512	413
640	512	693
320	256	2057
200	200	3206

4.2 SWIR 900-1700 0.33MP 15um(11)

4.2.1 SWIR331KMA-CL China Produced(3)

Table 38 SWIR331KMA-CL camera specification

Parameter	Model	SWIR331KMA-CL1000	SWIR331KMA-CL700	SWIR331KMA-CL500
	0.33M pixels 3/4" InGaAs CameraLink industrial camera			
Camera				
Sensor model	China produced 1280x1024			
Sensor type	InGaAs CMOS			
Spectral range	900nm - 1700nm			
pixel size	15 μm x 15 μm			
Target size	3/4"			
ADC	14-bit			
Frame Rate & Resolution	1000fps@640 x 512		724fps@640 x 512	517fps@640 x 512
Memory	512MB			
QE	75%@ 1350nm			
Conversion gain	970.01e-/DN(LG), 18.02e-/DN(MG), 3.31e-/DN (HG)			
Dynamic Range	69.2dB(LG), 63.2dB(MG), 57.4dB(HG) *1			
Read noise	1.3DN(LG), 2.7DN(MG), 5.0DN(HG)			
Full well charge	3.5Me(LG), 70Ke(MG), 12Ke(HG) *1			
Maximum SNR	65.4dB(LG), 48.5dB(MG), 40.7dB(HG)			
Dark current	30fa@0.1V&18°C			
Exposure time range	16us~1s			
Shutter mode	Global shutter			
Data interface	CameraLink Full			
Digital I/O	1 optocoupler isolated input, 1 optocoupler isolated output			
Data Format	Mono 12 / Mono 14			
Cooling temperature difference	40°C below ambient temperature			
Camera type	Nationally produced devices			
General parameters				
Power supply	DC12V power supply			
Power consumption	8.4W (TEC OFF) / <16W (TEC ON)			
Temperature	Working temperature -30 ~ 60 °C, storage temperature - 40 ~ 85 °C			
Humidity	20%-80% , non-condensing			
Size	68mm×68mm×90.3mm			
Weight	485g			
Lens mount	C-mount interface			
Software	Provide SDK development kit and CL View software based on Delsa acquisition card			

*1: LG: CDS-OFF, DeNoise-ON; MG: CDS-ON, DeNoise-OFF; HG: CDS-ON, DeNoise-OFF.

4.2.2 SWIR331KMB-CL(3)

Table 39 SWIR331KMB-CL camera specification

Parameter	Model	SWIR331KMB-CL1000	SWIR331KMB-CL700	SWIR331KMB-CL500
	0.33M pixels 3/4" InGaAs CameraLink industrial camera			
Camera				
Sensor model	China produced 1280x1024			
Sensor type	InGaAs CMOS			
Spectral range	900nm - 1700nm			
pixel size	15 μm x 15 μm			
Target size	3/4"			
ADC	14-bit			
Frame Rate & Resolution	1000fps@640 x 512		724fps@640 x 512	
Memory	512MB			
QE	75%@ 1350nm			
Conversion gain	970.01e-/DN(LG), 18.02e-/DN(MG), 3.31e-/DN (HG)			
Dynamic Range	69.2dB(LG), 63.2dB(MG), 57.4dB(HG) *1			
Read noise	1.3DN(LG), 2.7DN(MG), 5.0DN(HG)			
Full well charge	3.5Me(LG), 70Ke(MG), 12Ke(HG) *1			
Maximum SNR	65.4dB(LG), 48.5dB(MG), 40.7dB(HG)			
Dark current	30fa@0.1V&18°C			
Exposure time range	16us~1s			
Shutter mode	Global shutter			
Data interface	CameraLink Full			
Digital I/O	1 optocoupler isolated input, 1 optocoupler isolated output			
Data Format	Mono 12 / Mono 14			
Cooling temperature difference	40°C below ambient temperature			
Camera type	High performance			
General parameters				
Power supply	DC12V power supply			
Power consumption	8.4W (TEC OFF) / <16W (TEC ON)			
Temperature	Working temperature -30 ~ 60 °C, storage temperature - 40 ~ 85 °C			
Humidity	20%-80% , non-condensing			
Size	68mm×68mm×90.3mm			
Weight	485g			
Lens mount	C-mount interface			
Software	Provide SDK development kit and CL View software based on Delsa acquisition card			

*1: LG: CDS-OFF, DeNoise-ON; MG: CDS-ON, DeNoise-OFF; HG: CDS-ON, DeNoise-OFF.

4.2.3 SWIR331KMB-G(3)

Table 40 SWIR331KMB-G camera specification

Parameter	Model	SWIR331KMB-G125	SWIR331KMB-G350	SWIR331KMB-G700
	0.33M pixels 3/4" InGaAs GigE camera			
Camera				
Sensor model	China produced			
Sensor type	InGaAs CMOS			
Spectral range	900nm - 1700nm			
pixel size	15 μm x 15 μm			
Target size	3/4"			
ADC	14-bit			
Frame Rate & Resolution	8bit: 125@640x512 14bit: 125@640x512		8bit: 360@640x512 14bit: 145@640x512	8bit: 360@640x512; 700@320x256 14bit: 180@640x512 ROI1-5: Detailed parameters are shown in Table 7 of 2.4 Frame Rate and ROI
Memory	512MB			
QE	75%@ 1350nm			
Conversion gain	138.6e-/ADU(LG), 5.54e-/ADU(MG), 1.2e-/ADU (HG)			
Dynamic Range	70.59dB(LG), 67.96dB(MG), 47.98dB(HG) *1			
Read noise	586.82e(LG), 35.05e(MG), 68.44e(HG)			
Full well charge	1986426.78e(LG), 87649.83Ke(MG), 17147.351e(HG) *1			
Maximum SNR	62.98dB(LG), 49.43dB(MG), 42.34dB(HG)			
Dark current	30fa@0.1V&18℃			
Exposure time range	25us~5s			
Shutter mode	Global shutter			
Data interface	GigE			
Digital I/O	1 optocoupler isolated input, 1 optocoupler isolated output, tow non-isolated input and output			
Data Format	Mono 8 / Mono 14			
Cooling temperature difference	40℃ below ambient temperature			
General parameters				
Power supply	DC12V power supply			
Power consumption	8.4W (TEC OFF) / <16W (TEC ON)			
Temperature	Working temperature -30 ~ 60 ℃, storage temperature - 40 ~ 85 ℃			
Humidity	20%-80% , non-condensing			
Size	68mm×68mm×90.3mm			
Weight	485g			
Lens mount	C-mount interface			
Software	Provide SDK development kit			

*1: LG: CDS-OFF, DeNoise-ON; MG: CDS-ON, DeNoise-OFF; HG: CDS-ON, DeNoise-OFF.

4.2.4 SWIR331KMB-10G

Table 41 SWIR331KMB-10G camera specification

Parameter	Model
	SWIR331KMB-10G 0.33M pixels 3/4" InGaAs 10G camera
Camera	
Sensor model	China produced 640x512
Sensor type	InGaAs CMOS
Spectral range	900nm - 1700nm
pixel size	15 μm x 15 μm
Target size	3/4"
ADC	14-bit
Frame Rate & Resolution	8bit: 724@640x512 14bit: 724@640x512
Memory	512MB
QE	75%@ 1350nm
Conversion gain	138.6e-/ADU(LG), 5.54e-/ADU(MG), 1.2e-/ADU (HG)
Dynamic Range	70.59dB(LG), 67.96dB(MG), 47.98dB(HG) *1
Read noise	586.82e(LG), 35.05e(MG), 68.44e(HG)
Full well charge	1986426.78e(LG), 87649.83Ke(MG), 17147.351e(HG) *1
Maximum SNR	62.98dB(LG), 49.43dB(MG), 42.34dB(HG)
Dark current	30fa@0.1V&18 $^{\circ}\text{C}$
Exposure time range	25us~5s
Shutter mode	Global shutter
Data interface	10GigE
Digital I/O	1 optocoupler isolated input, 1 optocoupler isolated output, tow non-isolated input and output
Data Format	Mono 8 / Mono 14
Cooling temperature difference	40 $^{\circ}\text{C}$ below ambient temperature
General parameters	
Power supply	DC12V power supply
Power consumption	8.4W (TEC OFF) / <16W (TEC ON)
Temperature	Working temperature -30 ~ 60 $^{\circ}\text{C}$, storage temperature - 40 ~ 85 $^{\circ}\text{C}$
Humidity	20%-80% , non-condensing
Size	68mm×68mm×90.3mm
Weight	485g
Lens mount	C-mount interface
Software	Provide SDK development kit / ToupView

*1: LG: CDS-OFF, DeNoise-ON; MG: CDS-ON, DeNoise-OFF; HG: CDS-ON, DeNoise-OFF.

4.2.5 SWIR331KMB-U700

Table 42 SWIR331KMB-U700 camera specification

Parameter	Model
	SWIR331KMB-U700 0.33M pixels 3/4" InGaAs USB camera Camera
Sensor model	China produced 640x512
Sensor type	InGaAs CMOS
Spectral range	900nm - 1700nm
pixel size	15 μm x 15 μm
Target size	3/4"
ADC	14-bit
Frame Rate & Resolution	8bit: 724@640x512 Packet12: 724@640x512 14bit: 579@640x512
Memory	512MB
QE	75%@ 1350nm
Conversion gain	138.6e-/ADU(LG), 5.54e-/ADU(MG), 1.2e-/ADU (HG)
Dynamic Range	70.59dB(LG), 67.96dB(MG), 47.98dB(HG) *1
Read noise	586.82e(LG), 35.05e(MG), 68.44e(HG)
Full well charge	1986426.78e(LG), 87649.83Ke(MG), 17147.351e(HG) *1
Maximum SNR	62.98dB(LG), 49.43dB(MG), 42.34dB(HG)
Dark current	30fa@0.1V&18℃
Exposure time range	16us~1s
Shutter mode	Global shutter
Data interface	USB3
Digital I/O	1 optocoupler isolated input, 1 optocoupler isolated output, tow non-isolated input and output
Data Format	Mono 8 / Mono 14 / Packet12
Cooling temperature difference	40℃ below ambient temperature
General parameters	
Power supply	DC12V power supply
Power consumption	8.4W (TEC OFF) / <16W (TEC ON)
Temperature	Working temperature -30 ~ 60 ℃, storage temperature - 40 ~ 85 ℃
Humidity	20%-80% , non-condensing
Size	68mm×68mm×90.3mm
Weight	485g
Lens mount	C-mount interface
Software	Provide SDK development kit / ToupView

*1: LG: CDS-OFF, DeNoise-ON; MG: CDS-ON, DeNoise-OFF; HG: CDS-ON, DeNoise-OFF.

4.2.6 SWIR331 QE Curve

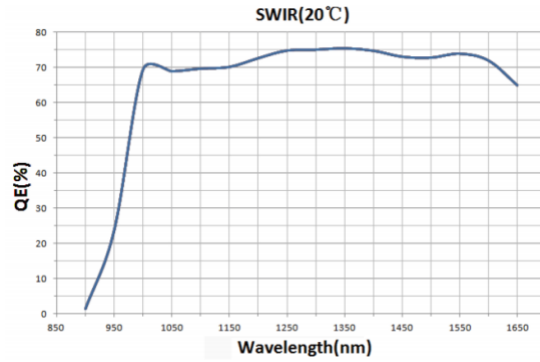

Figure 7 SWIR331 QE Curve

4.2.7 SWIR331 Frame rate and ROI frame rate

The camera support hardware ROI, the smaller the ROI size, the faster the frame rate

Table 43 CL1000 ROI typical frame rate

X Size	Y Size	FPS
640	512	1000
640	256	1978
320	256	3040
200	200	4816
112	112	10008

Table 44 CL700 ROI typical frame rate

X Size	Y Size	FPS
640	512	724
640	256	1432
320	256	2201
200	200	3487
120	120	6595

Table 45 CL500 ROI typical frame rate

X Size	Y Size	FPS
640	512	517
640	256	1023
320	256	1572
200	200	2491
120	120	4774

Table 46 GigE700 ROI typical frame rate

X Size	Y Size	FPS
640	512	360
640	256	710
320	256	1424
200	200	2810
120	120	3220

Table 47 GigE700 Y direction BIN2-4 Open the rear frame rate

X Size	Y Size	FPS
640	200	8bit: 920 14bit: 460
640	100	8bit: 1800 14bit: 920
640	50	8bit: 1800 14bit: 1800

Table 48 GigE125 ROI typical frame rate

X Size	Y Size	FPS
640	512	125
640	256	249
320	256	498
200	200	978
120	120	2460

Table 49 GigE350 ROI typical frame rate

X Size	Y Size	FPS
640	512	8bit: 358 14bit: 140
640	256	8bit: 358 14bit: 140
320	256	8bit: 720 14bit: 280
200	200	8bit: 1098 14bit: 430
120	120	8bit: 1421 14bit: 557

5 Camera functions and features

5.1 10G / 5G / 2.5G / GigE camera specification

The GigE camera requires the host card's jumbo frame mode to be enabled to achieve the highest frame rate.

Ensure that the IP addresses of the GigE camera and PC network card are in the same network segment.

Support multiple cameras to work simultaneously and synchronize acquisition through external trigger interfaces.

5.2 CameraLink camera specification

The Cameralink camera transfers data using Geometry_1X4_1Y mode, the 12-bit camera transfers data in Medium mode, and the 14-bit camera transfers data in Full mode.

5.3 Camera operation mode

Camera operation mode support: Video Mode or Trigger Mode.

Camera Trigger Mode support: Soft Trigger Mode(Software) or External Trigger Mode(Isolated input, GPIO0, GPIO1, Counter or PWM).

5.4 Bit depth and ROI control

SWIR series has a built-in 12bit t / 14bit ADC, and the camera also support hardware ROI. The smaller the ROI size, the faster the frame rate.

5.5 Bandwidth and precise frame rate control

5.5.1 Bandwidth

SWIR series support bandwidth adjustment from 1% to 100%. As shown in Figure 8, the camera is with 100% bandwidth by default, and you can drag the slider to set the desired bandwidth.

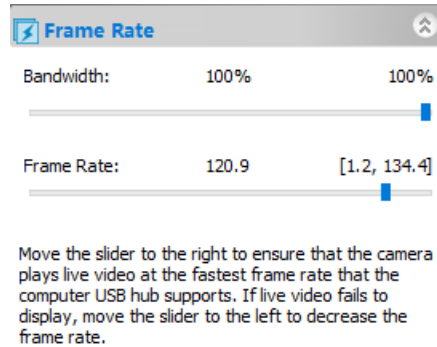

Figure 8 Bandwidth and precise frame rate settings

5.5.2 Precise frame rate control

SWIR series support precise frame rate control. The frame rate range will vary based on bandwidth, bit depth, resolution, ROI. As shown in Figure 8, the current frame rate can be set by dragging the Bandwidth or Frame Rate slider bar left or right.

5.6 DDR3 buffer

SWIR series has a built-in 512MB (4Gb) DDR3 buffer, which can effectively improve the stability of USB3 / Cameralink / GigE data transmission and ensure that the camera does not lose frames when working.

5.7 Binning

SWIR series support additive or averaged 1x1 to 8x8 digital binning, and averaged 1x1 to 2x2 hardware binning. Hardware binning can achieve higher frame rates than software binning.

5.8 DC12V power supply and cooling system

When the DC12V power supply is plugged in, both the camera cooling system and the imaging system use a unified 12V power supply.

For USB camera, when the DC12V power supply is disconnected, the camera cooling system stops working, and the imaging system will automatically switch to the USB 5V power supply and the camera can work normally in passive cooling mode.

For GigE and CameraLink camera, when the DC12V power supply is disconnected, the camera cant work.

The cooling system of SWIR series has a built-in or external TEC cooling for the sensor. It uses an external heat dissipation structure and a fan to assist heat dissipation. The working temperature can be adjusted to a specific value, and the effective cooling temperature can be lower than the ambient temperature by 10 - 25 °C. The efficient cooling system guarantees extremely low dark current levels.

The TEC system is controlled by PID algorithm, so that the TEC can be accurately adjusted to the target temperature, and the temperature deviation is 0.1°C.

5.9 Camera performance analysis

The performance of the camera can be evaluated by [e-/ADU](#), [Readout Noise](#), [Full Well](#) and [Dynamic Range](#).

e-/ADU: The electron signal of the CCD/CMOS camera is converted into a digital signal through a series of circuits such as readout, amplification, and analog-to-digital converter. The converted digital signal unit is called [ADU](#). The conversion factor is e-/ADU.

Readout Noise: Readout noise is the most important reference indicator for measuring camera performance. Low readout noise usually means better signal-to-noise ratio and better image quality. Readout noise occurs when electrons go through steps such as analog-to-digital conversion, amplification, and processing to create an image during readout.

Full Well: The maximum capacity of how many electrons could be held by each pixel of the camera. Under the same conditions of noise and A/D conversion, the larger the full-well charge capacity of the sensor, the wider the dynamic range.

Dynamic Range: Dynamic range is specified as the maximum achievable signal divided by the camera noise, where the signal strength is determined by the full-well capacity and noise is the sum of dark and readout noises.. Dynamic range represents the camera's ability to display the brightest and darkest parts of an image and how much there is variation between the two. There may be one part of an image that is completely black and another part that is completely saturated.

For SWIR series, when describing camera performance, [Gain Value](#) In xxx% mode, here use xxx as the x - axis ([Gain Value](#))

$$Rel\ Gain(dB) = 20 * \log_{10}[xxx(Gain\ Value)/100]$$

$$xxx(Gain\ Value) = 100 \times 10^{(Rel\ Gain(dB)/20)}$$

For details about the performance of the camera, see the parameters of each model or series.

5.10 Lens design guidelines

Information on lens selection is provided below.

The sensor imaging and the lenses are shown in Figure 9 and Figure 10.

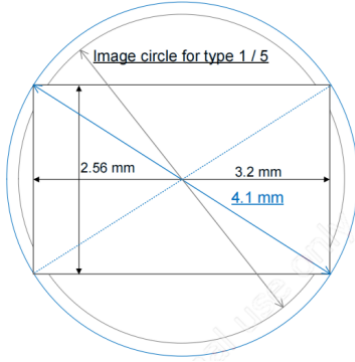

Figure 9 IMX991 relationship between image circle and pixel area

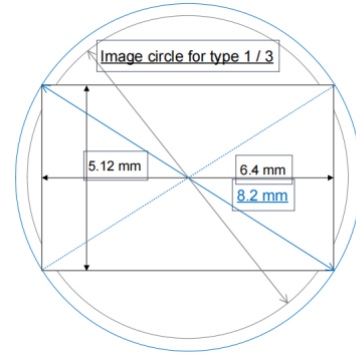

Figure 10 IMX990 relationship between image circle and pixel area

The following figure recommends the characteristics of CRA when the image height is from 0-100%.

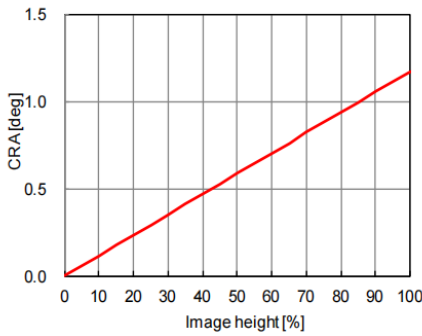

Figure 11 IMX991 CRA characteristics

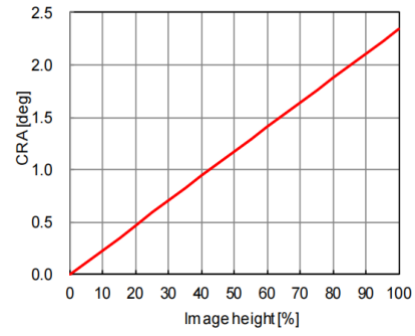

Figure 12 IMX990 CRA characteristics

Table 50 CRA(Chief Ray Angle) characteristics

IMX991			IMX990		
Image height		CRA (deg)	Image height		CRA (deg)
(%)	(mm)		(%)	(mm)	
0	0.00	0.00	0	0.00	0.00
5	0.10	0.06	5	0.20	0.12
10	0.20	0.12	10	0.41	0.23
15	0.31	0.18	15	0.61	0.35
20	0.41	0.23	20	0.82	0.47
25	0.51	0.29	25	1.02	0.59
30	0.61	0.35	30	1.23	0.70
35	0.72	0.41	35	1.43	0.82
40	0.82	0.47	40	1.64	0.94
45	0.92	0.53	45	1.84	1.06
50	1.02	0.59	50	2.05	1.17
55	1.13	0.65	55	2.25	1.29
60	1.23	0.70	60	2.46	1.41
65	1.33	0.76	65	2.66	1.53
70	1.43	0.82	70	2.87	1.64
75	1.54	0.88	75	3.07	1.76
80	1.64	0.94	80	3.28	1.88

85	1.74	1.00	85	3.48	1.99
90	1.84	1.06	90	3.69	2.11
95	1.95	1.12	95	3.89	2.23
100	2.05	1.17	100	4.10	2.35

5.11 Filter

The SWIR series uses two filters: the long wave pass filter LPF390H and the long wave pass filter LP1000H.

LPF390H: D25X1MM cuts off 200-375HR- pass through 400-1800HT-T90-OD5

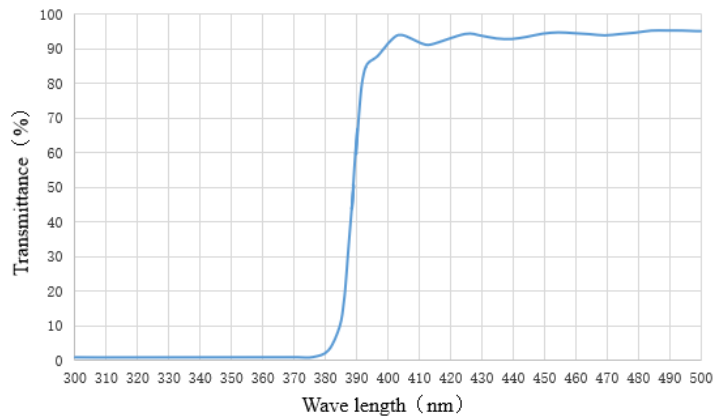

Figure 13 Long wave pass filter LPF390H transmittance curve

LP1000H: D25x2MM 200-980HR-1030-1800NM T90-OD5

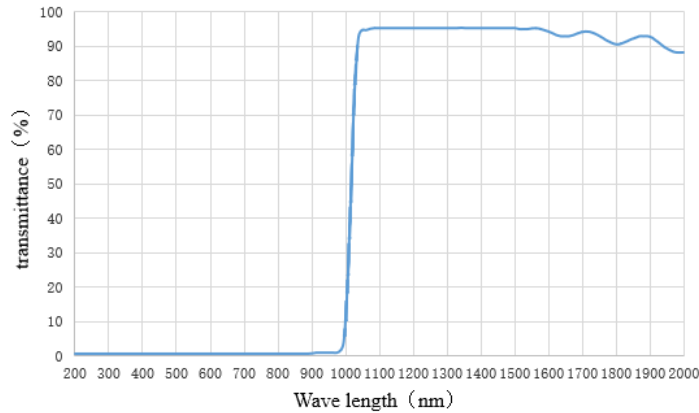
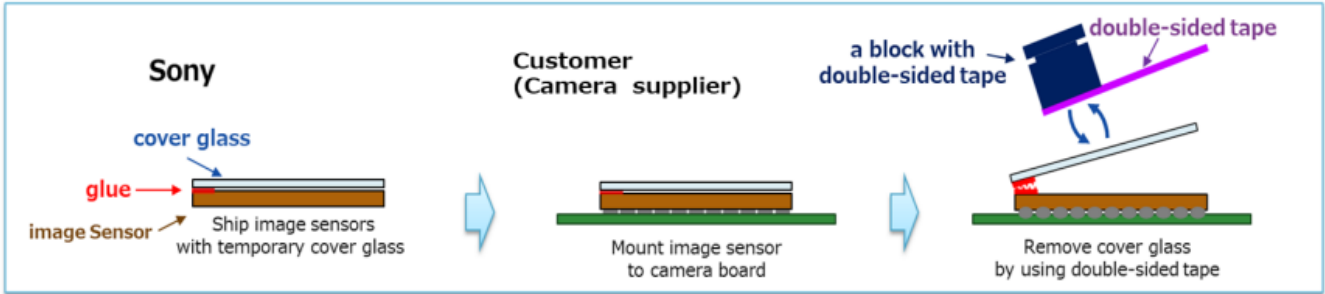

Figure 14 Long wave pass filter LP1000H transmittance curve

5.12 RG version description

SWIR1300KMB-UMV and SWIR330KMB-UMV are available in RG (de-glazing) versions, as shown in the figure below.



5.13 C0 version description

SWIR331KMB-U700 and SWIR331KMB-G125 are available in C0 (Class0) versions with support for long exposure mode and deep cooling to -45 degrees.

6 Camera dimensions and port

6.1 SWIR 400-1700 Camera dimensions

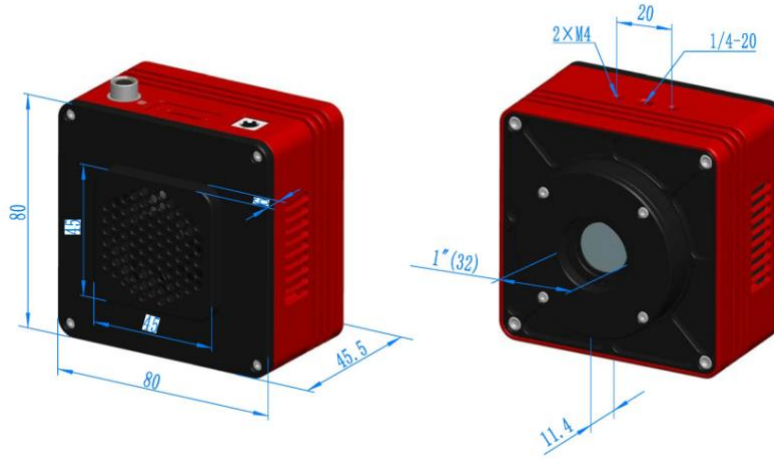

Figure 15 USB interface Cooled Camera dimensions

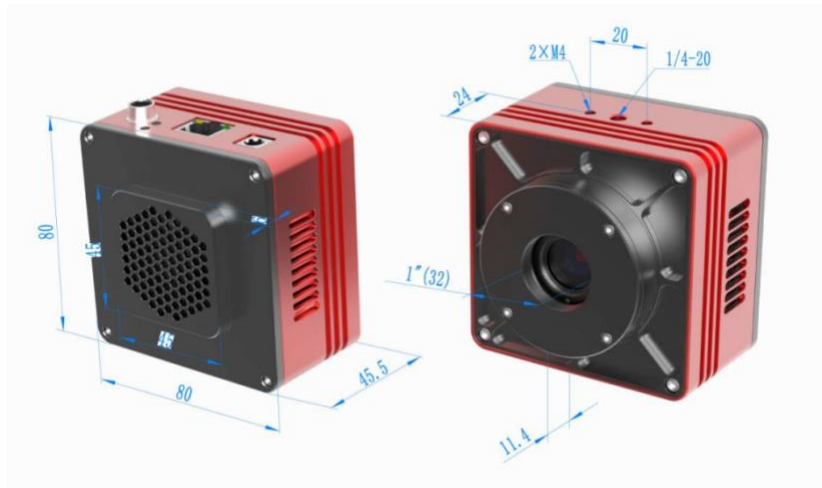

Figure 16 GigE interface Cooled Camera dimensions

Table 51 Cooled Camera dimensions specification

Parameter	Specification
Size	80*80*45.5mm
Mount	C mount

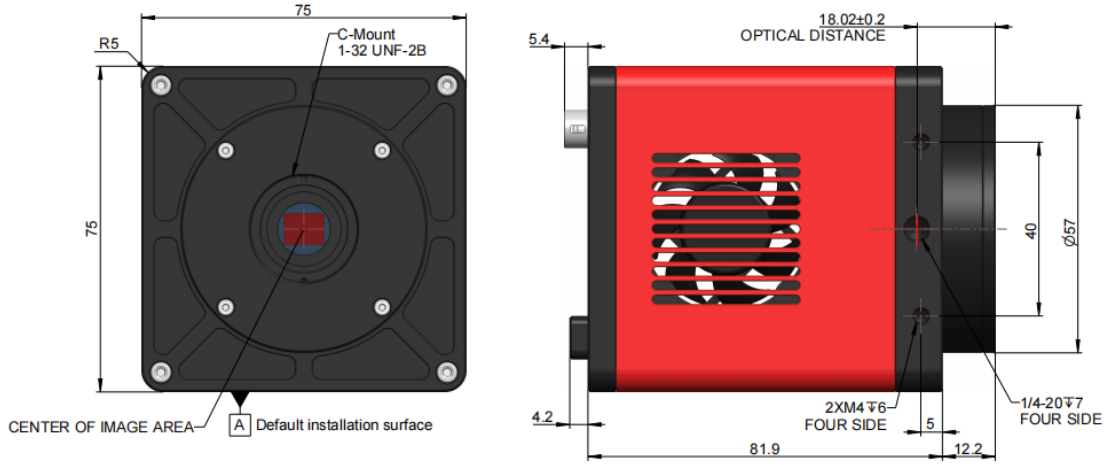

Figure 17 CL interface Cooled Camera dimensions

Table 52 Cooled Camera dimensions specification

Parameter	Specification
Size	75*75*81.9mm
Mount	C mount



Figure 18 USB interface uncooled camera dimensions

Table 53 Uncooled camera dimensions specification

Parameter	Specification
Size	33*33*38mm
Mount	C mount

6.2 SWIR 400-1700 Camera port

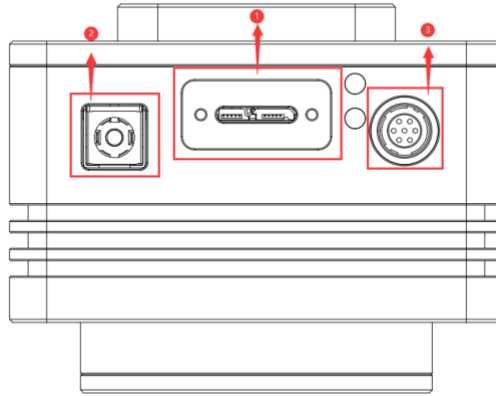

Figure 19 USB interface Cooled Camera

Table 54 USB interface Cooled Camera specification

Item	Specification
1	USB3.0 port
2	DC 12V power
3	External IO connection port

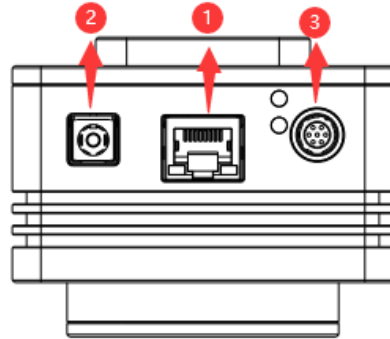

Figure 20 GigE interface Cooled Camera

Table 55 GigE interface Cooled Camera specification

Item	Specification
1	GigE port
2	DC 12V power
3	External IO connection port

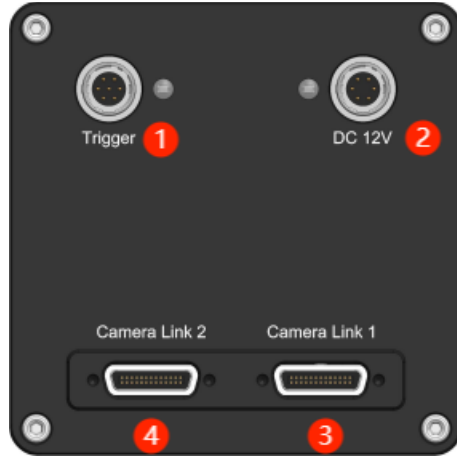

Figure 21 CL interface Cooled Camera

Table 56 CL interface Cooled Camera specification

Item	Specification
1	External IO connection port
2	DC 12V power
3	CameraLink1
4	CameraLink2

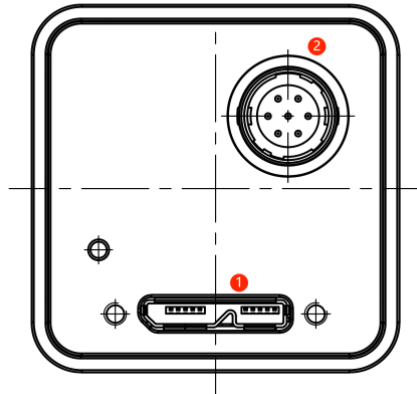

Figure 22 USB interface uncooled camera

Table 57 USB interface uncooled camera specification

Item	Specification
1	USB3.0 port
2	External IO connection port

6.3 SWIR 900-1700 Camera dimensions

6.3.1 SWIR331 Camera dimensions

The camera can be rotated 90 degrees to change the forward direction. Customers can choose the appropriate installation direction according to their needs, please explain when placing an order.

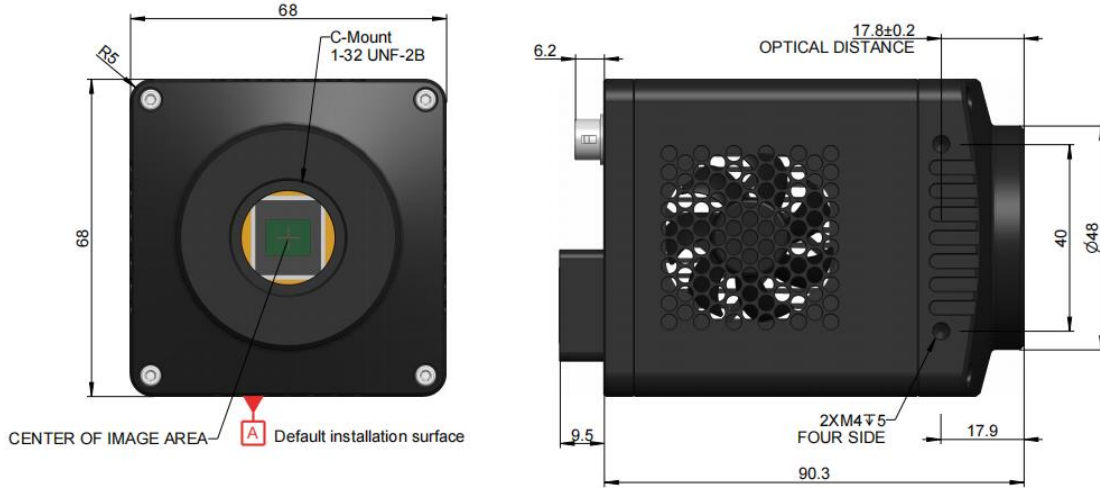

Figure 23 The Front and side view dimensions of the GigE interface camera

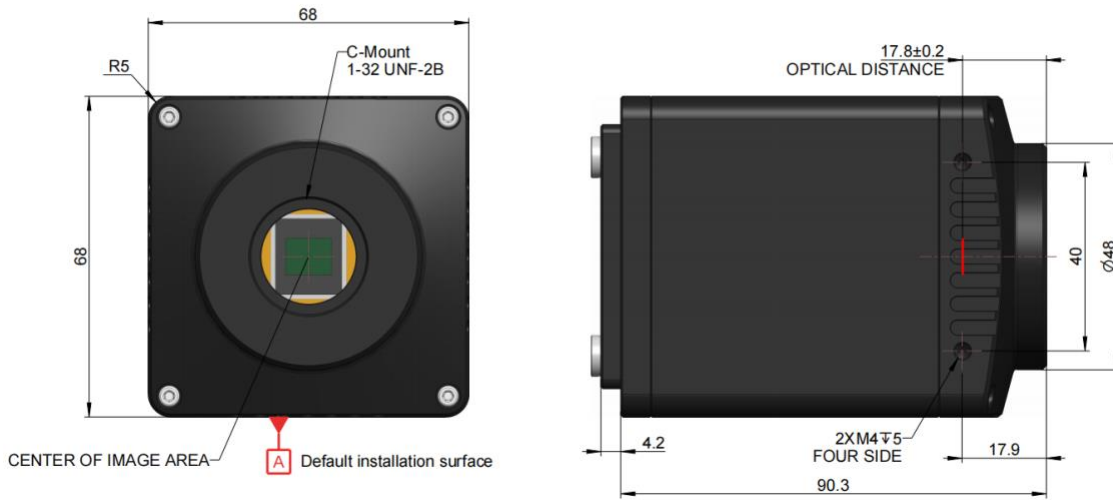

Figure 24 The Front and side view dimensions of the USB interface camera

Table 58 Dimensions specification

Parameter	Specification
Size	68*68*90.3mm
Mount	C mount

6.3.2 SWIR1302 Camera dimensions

The camera can be rotated 90 degrees to change the forward direction. Customers can choose the appropriate installation direction according to their needs, please explain when placing an order.

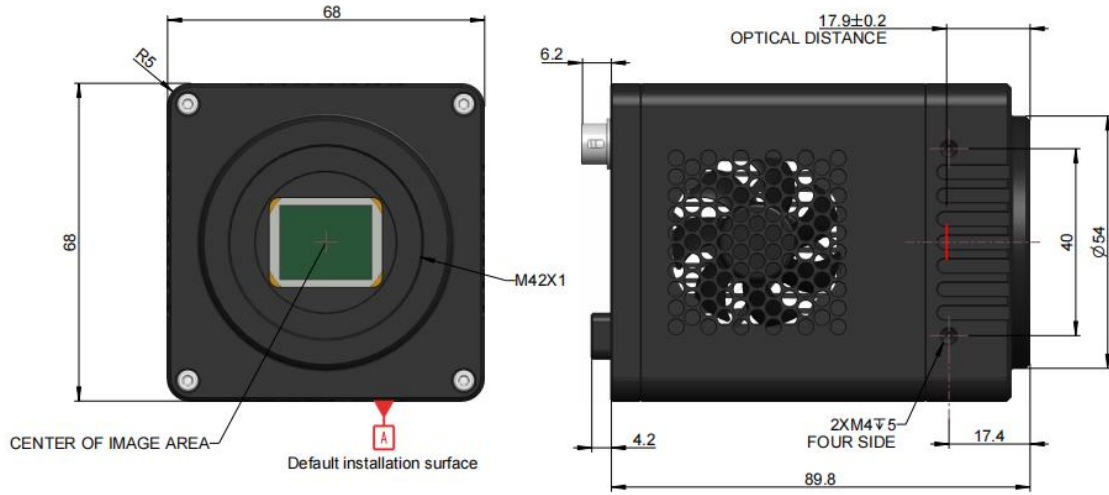

Figure 25 The Front and side view dimensions of the CL interface camera

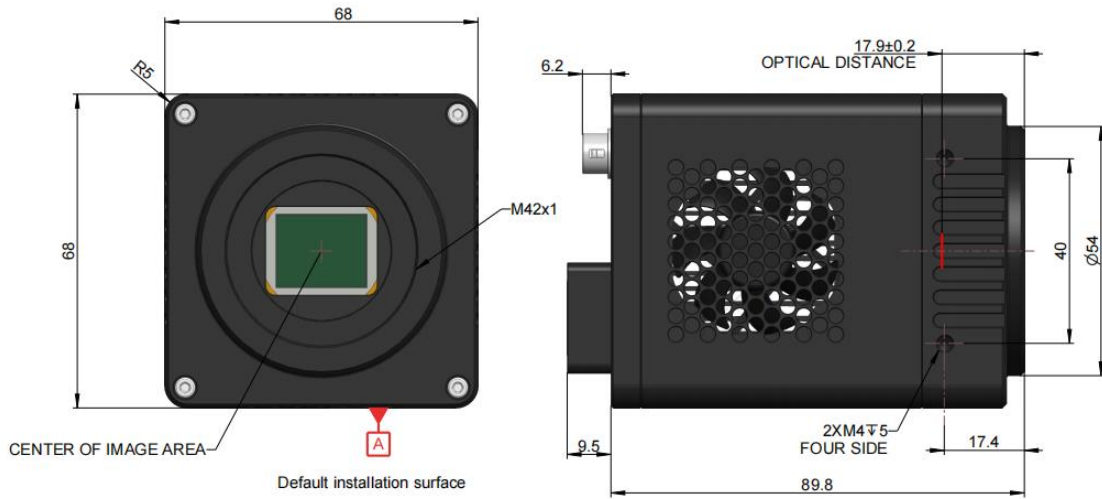

Figure 26 The Front and side view dimensions of the GigE interface camera

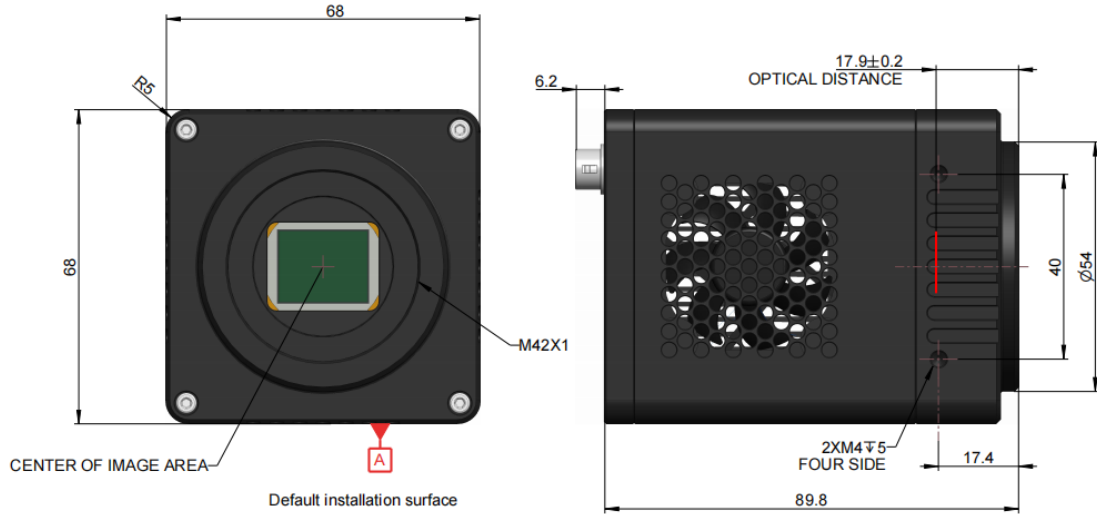

Figure 27 The Front and side view dimensions of the USB interface camera

Table 59 Dimensions specification

Parameter	Specification
Size	68*68*89.8mm
Mount	M42

6.4 SWIR 900-1700 Camera port



Figure 28 CL interface Cooled Camera

Table 60 CL interface Cooled Camera specification

Item	Specification
1	DC 12V power
2	External IO connection port
3	CameraLink1
4	CameraLink2

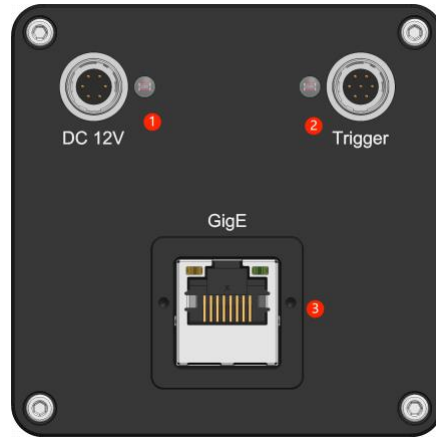

Figure 29 GigE interface Cooled Camera

Table 61 GigE interface Cooled Camera specification

Item	Specification
1	DC 12V power
2	External IO connection port
3	GigE port



Figure 30 USB interface Cooled Camera

Table 62 USB interface Cooled Camera specification

Item	Specification
1	DC 12V power
2	External IO connection port
3	USB port

7 Packing list

7.1 SWIR 400-1700 camera packing list



Figure 31 USB Cooled Camera packing information

Table 63 USB Cooled Camera packing list

Standard Packaging List	
A	External box for B(not shown in this figure) Carton size: L:28.2cm W:25.2cm H:16.7cm
B	3-A safety equipment case: L:28cm W:23cm H:15.5cm (1pcs, 2.8Kg/ box)
C	SWIR 400-1700 series USB Cooled Camera
D	Power cord. National standard, American standard, European standard, British standard power cord (D1, D2, D3, D4) for choosing
E	Power adapter: Input: AC 100~240V 50Hz/60Hz, Output: DC 12V 3A
F	High-speed USB3.0 A male to B male gold-plated connector cable/1.5m
G	One external trigger control cable
H	USB flash disk (with driver and application software in it)



Figure 32 GigE Cooled Camera packing information

Table 64 GigE Cooled Camera packing list

Standard Packaging List	
A	External box for B(not shown in this figure) Carton size: L:28.2cm W:25.2cm H:16.7cm
B	3-A safety equipment case: L:28cm W:23cm H:15.5cm (1pcs, 2.8Kg/ box)
C	SWIR 400-1700 series GigE Cooled Camera
D	Power cord. National standard, American standard, European standard, British standard power cord (D1, D2, D3, D4) for choosing
E	Power adapter: Input: AC 100~240V 50Hz/60Hz, Output: DC 12V 3A
F	One external trigger control cable
G	GigE cable: G1:3m G2:5m G3:10m(G4: 50m not shown in this figure)
H	USB flash disk (with driver and application software in it)



Figure 33 CL Cooled Camera packing information

Table 65 CL Cooled Camera packing list

Standard Packaging List	
A	3-A safety equipment case: L:28cm W:23cm H:15.5cm (1pcs, 2.8Kg/ box)
B	SWIR 400-1700 series CL Cooled Camera
C	2 CameraLink cables
D	12V/3A 6 PIN air plug power adapter
E	Power cord. National standard, American standard, European standard, British standard power cord (E1, E2, E3, E4) for choosing
F	One external trigger control cable



Figure 34 USB uncooled camera packing information

Table 66 USB uncooled camera packing list

Standard Packaging List	
A	External box for B(not shown in this figure) Carton size: L:28.2cm W:25.2cm H:16.7cm
B	3-A safety equipment case: L:28cm W:23cm H:15.5cm (1pcs, 2.8Kg/ box)
C	SWIR 400-1700 series USB uncooled camera
D	High-speed USB3.0 A male to B male gold-plated connector cable/1.5m
E	One external trigger control cable
F	USB flash disk (with driver and application software in it)

7.2 SWIR 900-1700 camera packing list



Figure 35 CL camera packing information

Table 67 CL camera packing list

Standard Packaging List	
A	3-A safety equipment case: L:28cm W:23cm H:15.5cm (1pcs, 2.8Kg/ box)
B	SWIR 900-1700 series CL camera
C	2 CameraLink cables
D	12V/3A 6 PIN air plug power adapter
E	Power cord. National standard, American standard, European standard, British standard power cord (E1, E2, E3, E4) for choosing
F	One external trigger control cable



Figure 36 GigE camera packing information

Table 68 GigE camera packing list

Standard Packaging List	
A	External box for B(not shown in this figure) Carton size: L:28.2cm W:25.2cm H:16.7cm
B	3-A safety equipment case: L:28cm W:23cm H:15.5cm (1pcs, 2.8Kg/ box)
C	SWIR 900-1700 series GigE camera
D	12V/3A 6 PIN air plug power adapter
E	Power adapter: Input: AC 100~240V 50Hz/60Hz, Output: DC 12V 3A
F	One external trigger control cable
G	GigE cable: G1:3m G2:5m G3:10m(G4: 50m not shown in this figure)
H	USB flash disk (with driver and application software in it)



Figure 37 USB camera packing information

Table 69 USB camera packing list

Standard Packaging List	
A	3-A safety equipment case: L:28cm W:23cm H:15.5cm (1pcs, 2.8Kg/ box)
B	SWIR 900-1700 series USB camera
C	High-speed USB3.0 A male to B male gold-plated connector cable/1.5m
D	12V/3A 6 PIN air plug power adapter
E	Power adapter: Input: AC 100~240V 50Hz/60Hz, Output: DC 12V 3A
F	One external trigger control cable

8 External IO connector and electrical characteristics

8.1 SWIR 400-1700 camera Pin signal

Table 70 USB port、GigE port、 CL port Cooled Camera pin signal definitions

	Color	Pin	Signal	Description of the signal
	White	1	GDN	Direct-coupled signal ground
	Red	2	12V	12VDC power input
	Blue	3	OPTO_GND	Opto-isolated signal ground
	Yellow	4	DIR_GPIO0	Direct-coupled General Purpose I/O (Software configurable input/output) (line2)
	Black	5	DIR_GPIO1	Direct-coupled General Purpose I/O (Software configurable input/output) (line3)
	Green	6	OPTO_IN	Opto-isolated input signal (line0)
	Pink	7	OPTO_OUT	Opto-isolated output signal (line1)

Table 71 USB uncooled camera(UMV) pin signal definition

	Color	Pin	Signal	Signal description
	red	1	DIR_GPIO	Direct-coupled General Purpose I/O (Software configurable input / output) (line2)
	white	2	OPTO_GND	Opto-isolated signal ground
	blue	3	OPTO_OUT	Opto-isolated output signal(line1)
	green	4	OPTO_IN	Opto-isolated input signal(line0)
	black	5	GND	Direct-coupled signal ground
	yellow	6	5V	5 VDC power input

8.2 SWIR 900-1700 camera Pin signal

Table 72 DC12V pin signal definitions

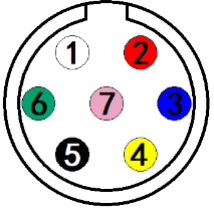
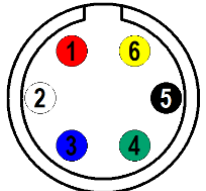
	Color	Pin	Signal	Description of the signal
	Red	1	12V	12V power supply positive
	Yellow	6	12V	
	Black	5	12V	
	White	2	GND	12V power supply negative
	Blue	3	GND	
	Green	4	GND	

Table 73 CL port Trigger pin signal definitions

	Color	Pin	Signal	Signal description
	Blue	3	OPTO_GND	Opto-isolated signal ground
	Green	6	OPTO_IN	Opto-isolated input signal (line0)
	Pink	7	OPTO_OUT	Opto-isolated output signal (line1)

Table 74GigE and USB port Trigger pin signal definitions

Color	Pin	Signal	Signal description
White	1	GND	Direct-coupled signal ground
Red	2	12V	12VDC power input or output
Blue	3	OPTO_GND	Opto-isolated signal ground
Yellow	4	DIR_GPIO0	Direct-coupled General Purpose I/O (Software configurable input/output) (line2)
Black	5	DIR_GPIO1	Direct-coupled General Purpose I/O (Software configurable input/output) (line3)
Green	6	OPTO_IN	Opto-isolated input signal (line0)

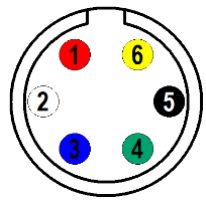
	Pink	7	OPTO_OUT	Opto-isolated output signal (line1)
---	------	---	----------	-------------------------------------

8.3 I/O electrical characteristics

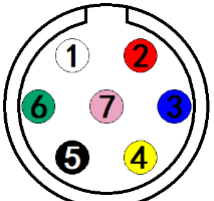
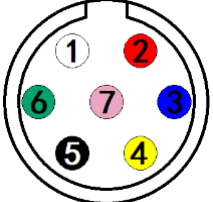
8.3.1 Opto-isolated input circuit (line0)

In the I/O control of the camera, the opto-isolated input circuit is shown in Figure 38.

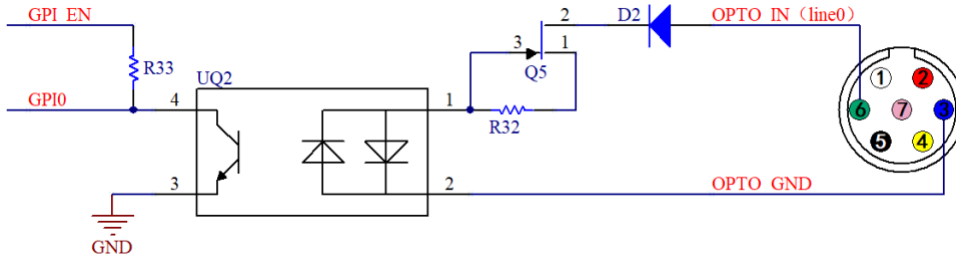

Figure 38 Opto-isolated input circuit

Logic 0 input level: 0~2.2VDC (OPTO_IN pin)

Logic 1 input level: 3.3~24VDC (OPTO_IN pin)

Maximum input current: 30mA

When the input level is between 2.2V and 3.2V, the circuit operation state is uncertain, please do not let SWIR camera work within this voltage range.

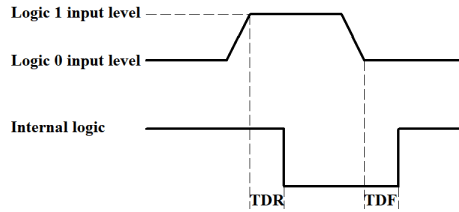

Figure 39 Input logic levels

Input rise delay (TDR): 6us

Input fall delay (TDF): 6us

8.3.2 Opto-isolated output circuit (line1)

In the camera I/O control, the opto-isolated output circuit is shown in Figure 40.

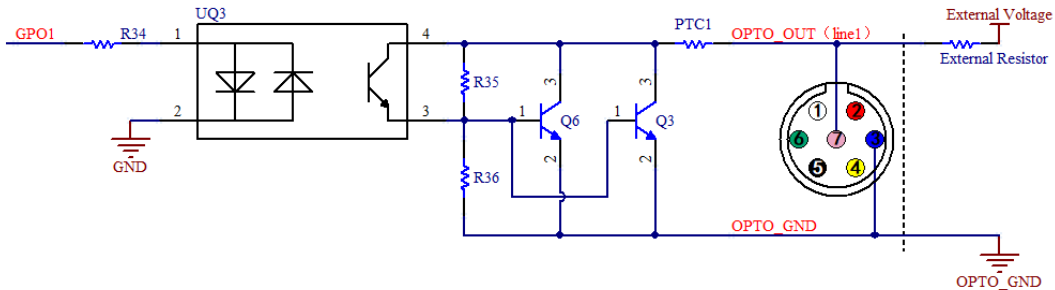

Figure 40 Optocoupler output circuit

The opto-isolated output maximum current is 30mA.

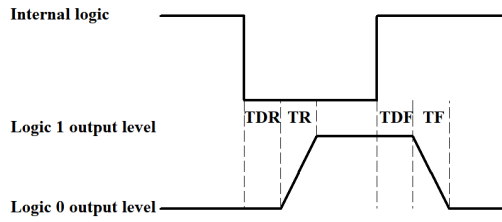

Figure 41 Output logic levels

The electrical characteristics of the opto-isolated output (external voltage 5V, external resistor 1K) are shown in Table 75.

Table 75 Opto-isolated output signal's electrical characteristics

Parameter name	Parameter notation	Parameter value
Output logic low	VL	742mV
Output logic high	VH	4.134V
Output rise time	TR	4us
Output fall time	TF	1.8us
Output rise delay	TDR	12us
Output fall delay	TDF	2us

The output of the corresponding output current and VL when using different voltages and resistors in external circuit are shown in Table 76.

Table 76 Opto-isolated output logic's low levels parameters

External voltage	External resistor	VL	Output current
3.3V	1KΩ	510mV	2.82mA
5V	1KΩ	742mV	4.31mA
12V	2.4KΩ	795mV	4.68mA
24V	4.7KΩ	850mV	4.97mA

8.3.3 Input and output I/O circuit (line2/line3)

The non-isolated configurable input and output I/O circuits are shown in Figure 42 and Figure 43.

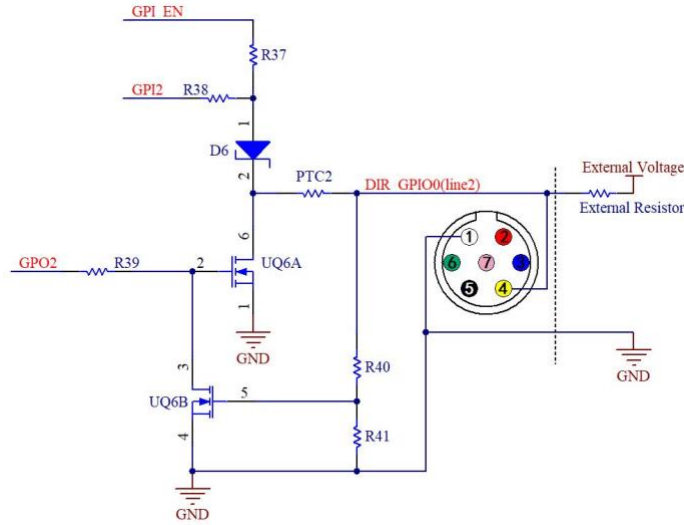

Figure 42 Non-isolated configurable input and output I/O circuit (line2)

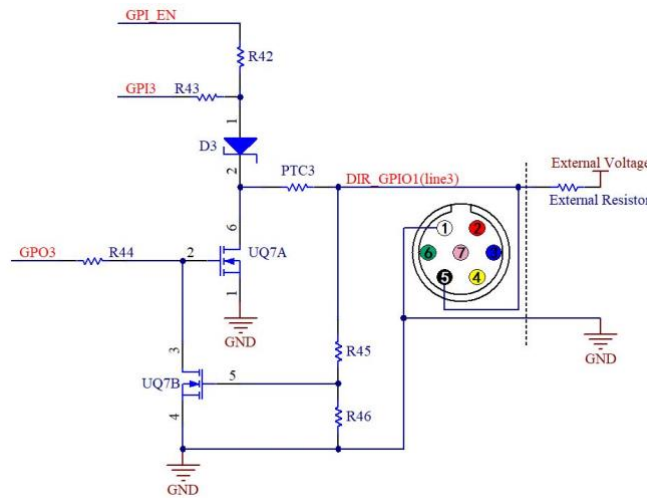

Figure 43 Non-isolated configurable input and output I/O circuit (line3)

1. Line2/line3 is set as input pin

Logic 0 input level: 0~0.6VDC (DIR_GPIO0/DIR_GPIO1 pins)

Logic 1 input level: 2.0~24VDC (DIR_GPIO0/DIR_GPIO1 pins)

Maximum input current: 25mA

When the input level is between 0.6V and 2.0V, the circuit action state is uncertain, please avoid the input voltage range working in this range.

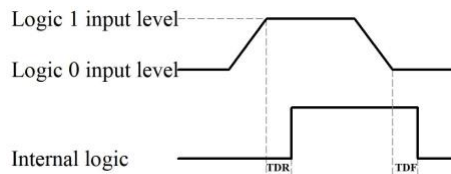

Figure 44 Input logic levels

To prevent damage to the GPIO pins, please connect the pin GND first, and then input voltage to the Line2 pin.

Input rise delay (TDR): 0.02us

Input fall delay (TDF): 0.02us

2.Line2/line3 are set as output pins

The maximum current allowed through this pin is 25mA.

When the ambient temperature is 25 degrees Celsius, the relationship between the external voltage, resistance and low-level vantage output is shown in Table 77.

Table 77 Non-isolated output Logic's low level parameters

External voltage	External resistor	VL (GPIO)
3.3V	1KΩ	0.11V
5V	1KΩ	0.167V
12V	2.4KΩ	0.184V
24V	4.7KΩ	0.385V

The external pull-up voltage is 5V, the pull-up resistor is 1KΩ, and the GPIO is configured to output the logic level and electrical characteristics as shown in Figure 45.

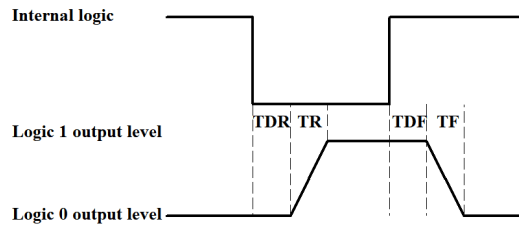

Figure 45 Output logic levels

Table 78 Non-isolated output electrical characteristics

Parameter name	Parameter notation	Parameter value
Output rise time	TR	0.08us
output fall time	TF	0.02us
Output rise delay	TDR	0.1us
Output fall delay	TDF	0.04us

9 ToupView Application

9.1 Application installation

In terms of software, customers are welcome to visit our website: <https://toupTek.com/download/> to download the latest ToupView. SWIR series can also be used with ASCOM, DirectShow interface. If the third-party software is compatible with these interfaces, customers can also download software drivers from our website and install them into the third-party software.

9.2 Introduction to ToupView

ToupView is a professional software that integrates camera control, image acquisition and processing, image browsing and analysis functions. ToupView has the following characteristics:

- x86: XP SP3 and above ; CPU support SSE2 and above
- x64: Win7 and above
- Support video mode and Trigger Mode (Raw format or RGB format)
- Automatic capture and quick recording capabilities
- Support multiple languages
- Hardware ROI and digital binning capabilities
- Rich image processing functions, such as image stitching, real-time overlay, flat field correction, dark field correction, etc.
- Support all ToupTek cameras

9.2.1 User interface design

- The menus and toolbars are properly set to ensure quick operation
- Professionally integrated with 5 sidebars - Camera, Folders, Undo/Redo, Layers, Measure
- Comfortable operation method (double-click or right-click context menu)
- Detailed help manual

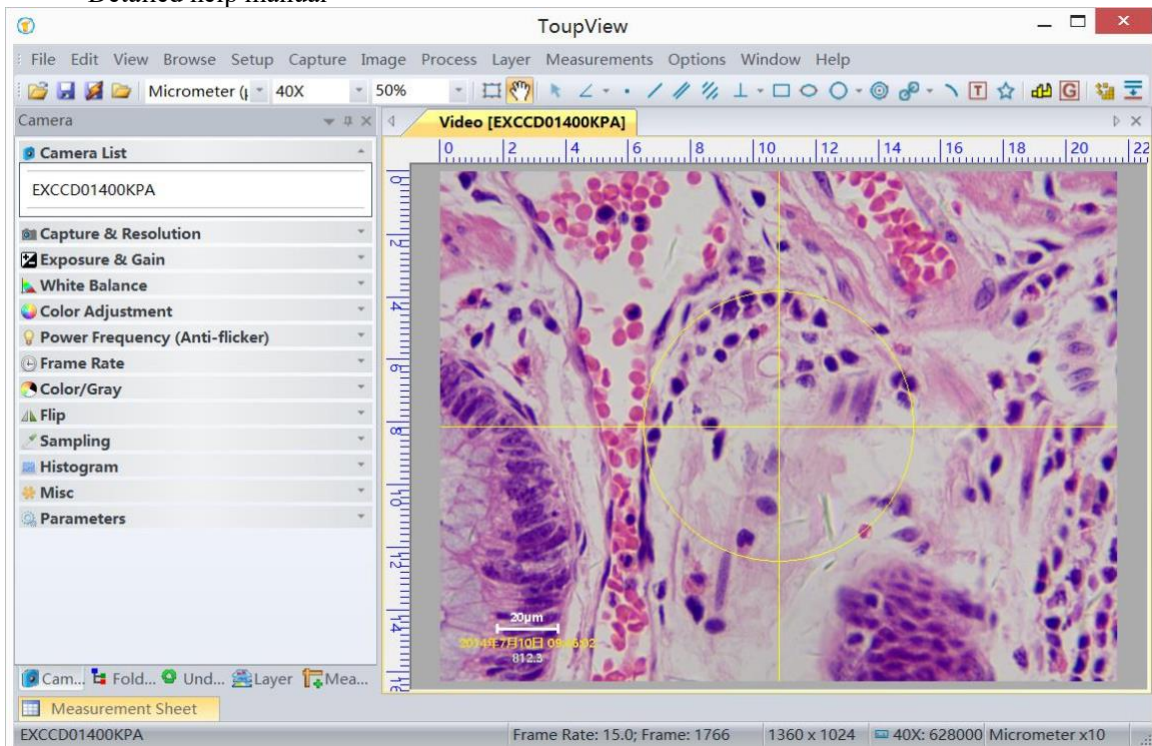

Figure 46 ToupView video window

9.2.2 Professional Camera Control Sidebar

Capture & Resolution	Set up live and still capture, snap images, or record video
Exposure & Gain	Auto exposure (preset exposure target value), manual exposure (exposure time can be manually entered and set by slider); gain up to 5 times
White Balance	Advanced one-click smart white balance settings, and you can adjust white balance by manually setting color temperature and color
Color Adjustment	Color, saturation, brightness, contrast, gamma initial high-speed adjustment function
Frame Rate Control	For different computer and USB performance, the camera can be super compatible by adjusting the frame rate
Flip	Select "Horizontal" or "Vertical" to adjust the sample orientation to ensure the same orientation as the visual system
Sampling	Neighborhood averaging can improve the signal-to-noise ratio of the video stream; while the sampling extraction mode can ensure the sharpness of the video stream. Support histogram expansion of video stream, image negative and positive switching, grayscale calibration, and sharpness factor calculation to facilitate video focusing
Bit Depth	8, 12-bit switching, 8-bit is the basic Windows image format. 12-bit has higher image quality but reduces frame rate
Roi	ROI, Region of interest. This function can set the ROI value of the video window. After the ROI group is expanded, a rectangular box will appear in the middle of the video window, and the ROI can be changed. The mouse can adjust the size of the ROI. If there is no problem with the ROI, click "Apply" to set the video to the size of the ROI, and the default value will be restored to the original size.
Dark Field Correction	To enable darkfield correction, you should first capture a field image, then click Enable. Check Enable to enable darkfield correction. Uncheck it to disable darkfield correction
Cooling	Set TEC Target Temperature, fan on/off
Parameter Save	Load, save, overwrite, load, export custom camera panel controls (including calibration information, exposure parameters and color settings information, etc.)

9.2.3 Professional and practical image processing functions

Video Function	Various video professional processing functions: video broadcasting, timing capture, video recording, video watermarking, watermark mobile alignment, watermark rotation alignment, video grid overlay, video measurement, video scaling, gray scale calibration, video high dynamic (HDR), video depth of field extension, video image stitching, video scale, date, etc.
Image Processing and Enhancement	Image contrast control and adjustment, image denoising, various image filtering algorithms, image mathematical morphology algorithms, image rotation, image scaling and image printing, etc.
Image Overlay	The ToupView image overlay denoising function introduces advanced image matching technology. Users only need to record a short video of the image to be superimposed, and they can superimpose and output high fidelity in the case of displacement, rotation and magnification change between multiple frames of the video. images, easy to use

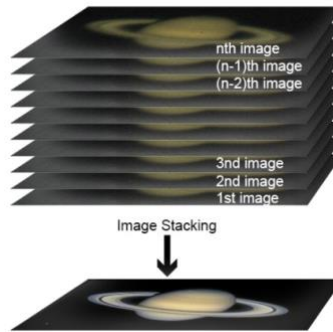

Figure 47 Image overlay denoising

9.2.4 Super compatibility

Camera Video Interface	Provide Twain, DirectShow, Labview, SDK installation package (native C++, C#)
Supported Operating Systems	Compatible with Microsoft® Windows® XP / Vista / 7 / 8 / 10 / 11(32 & 64 bit), Mac OSX, Linux
Language Support	Language support can be added manually, currently support English, Simplified Chinese, Traditional Chinese, German, Japanese, Russian, French, Italian, Polish, Turkish

9.2.5 Basic hardware requirements

PC Basic Configuration Requirements	CPU: Intel Core 2 2.8GHz or higher
	RAM: 2GB or more

USB Port: USB3.0 / USB 2.0
Monitor: 17" or higher
CD-ROM

9.3 Trigger Mode and its Configuration

9.3.1 Video mode and Trigger mode

The trigger function can be found on the **Capture & Resolution** group on the **Camera Sidebar** in **ToupView**. When the camera is opened, it is in **Video Mode** as shown in Figure 48 on the left. In **Video Mode**, **Auto Exposure**, **Exposure Target**, **Exposure Time** and **Gain** can be set. One can switch to **Trigger Mode** by checking the **Trigger Mode** check box.

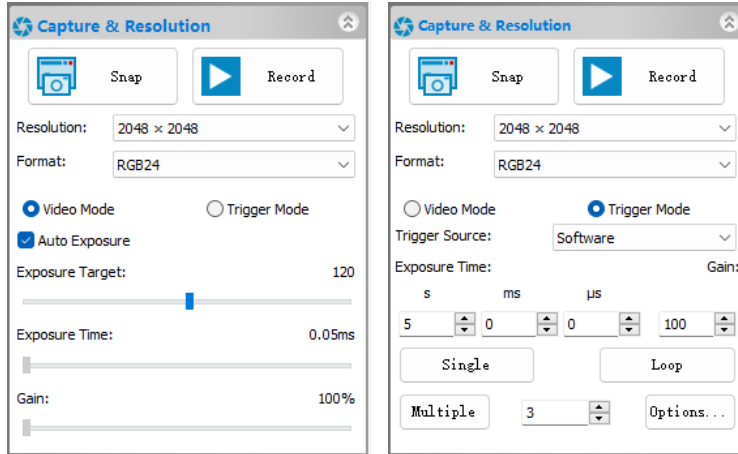

Figure 48 Video Mode and Trigger Mode on the Capture & Resolution group in ToupView

After the **Trigger Mode** is checked, the **Capture & Resolution** group will switch to **Trigger Mode** as shown in Figure 48 on the right. Where, the **Trigger Source**, **Exposure Time**, **Gain**, **Single**, **Loop**, **Multiple**, **Frame Box**, and **Options** can be set.

9.3.2 Trigger Sources and their capture style

The **Trigger Source** can be any external input signal inputted into the camera which is called **Hardware (Trigger Source)**, it can also be a command from the application which is called **Software (Trigger Source)**. For the **Software Trigger Source**, it can be **Single**, **Loop**, **Multiple**, or **Sequence** style. Figure 49 shows the possible **Trigger Sources**. Table 79 shows the designed **Trigger Source** descriptions and possible capture styles for ToupTek camera.

- Isolated input
- GPIO0
- GPIO1
- Counter
- PWM
- Software

Figure 49 Possible Trigger Sources

Table 79 Description of possible Trigger Sources and their capture styles

Trigger Source	Description
Isolated input	Logic 0 input level: 0~2.2VDC; Logic 1 input level: 3.3~24VDC;. Maximum input current: 30mA;
GPIO0	Logic 0 input level: 0~0.6VDC (DIR_GPIO0/DIR_GPIO1 pins); Logic 1 input level: 2.0~24VDC (DIR_GPIO0/DIR_GPIO1 pins); Maximum input current: 25mA; If GPIO0 is chosen as Trigger Source , it should be configured as Input in the GPIO Mode 's combo box on the Options>IO Control page;
GPIO1	Logic 0 input level: 0~0.6VDC (DIR_GPIO0/DIR_GPIO1 pins);

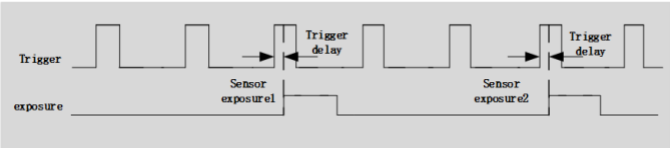
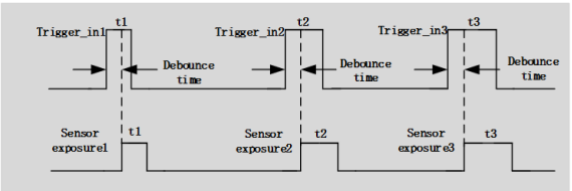
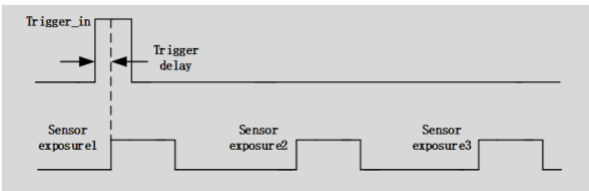
	<p>Logic 1 input level: 2.0~24VDC (DIR_GPIO0/DIR_GPIO1 pins); Maximum input current: 25mA; If GPIO1 is chosen as Trigger Source, it should be configured as Input in the GPIO Mode's combo box on the Options>IO Control page;</p>
<p>Counter</p>	<p>Counter refers to the operation mode in which the camera can divide the frequency of the external input trigger signal through the preset Counter Value and perform image acquisition according to the customer's logic. For example, when the counter value (Counter Value: <input type="text" value="3"/> [1,1023]) is set to 3, the camera needs to receive 3 trigger signals to trigger once;</p>  <p>When Counter is chosen in Trigger Source combo box in the Capture & Resolution group, the Counter Source can be Isolated input, GPIO0 or GPIO1 which can be chosen on Options>IO Control page; If GPIO0 or GPIO1 is chosen in the Counter Source combo box on Options>IO Control page. It should be configured as Input in the GPIO Mode combo box; Check Options>IO Control page's Line Select related items and Counter related items for details;</p>
<p>PWM</p>	<p>PWM refers to the operation mode in which the camera exposure time is controlled by the input trigger signal's pulse width;</p>  <p>PWM Trigger Source can be Isolated input, GPIO0 or GPIO1. If GPIO0 or GPIO1 is chosen in the PWM Source combo box on the Options>IO Control page, it should be configured as Input in the GPIO Mode combo box; Check Options>IO Control page's Line Select related items and PWM related items for details;</p>
<p>Software</p>	<p>When Software trigger is chosen, the client software can send the command through USB3.0 to trigger, acquire and transfer images, In ToupView, Single, Loop, Multiple, or Sequence can be used to send the Software trigger command; If the Plan or Hardware is chosen in the Type combo box on the Options>Sequence page, the Multiple button will switch to Sequence button and the camera will use the Exposure Time and Gain in the Sequence table on this page one by one to capture the specified frames. Check Single, Loop, Multiple, or Sequence on Capture & Resolution group for the Software capture operations; Check Options>Sequence page and Options>Advanced page for the related Sequence and Software capture setup options;</p>
<p>Single</p>	<p>When Single is clicked, the camera will start to capture the image. At the same time the Single button will switch to Stop button. Clicking Stop button to stop the current Single capture operation, the Stop button will switch to Single button again for the next capture operation; Note: 1) The captured frames will always Show in the video window to prevent too many captures; 2) Enabled when Software in the Trigger Source combo box is chosen or Always enable software trigger checkbox is checked on the Options>Advanced property page;</p>
<p>Loop</p>	<p>When Loop is clicked, the camera will start to capture the image continuously and the Loop button will switch to Stop button. Clicking Stop button to stop Loop captures and the Stop button will switch to Loop button for the next Loop capture operation; Note: 1)The captured frames will always Show in the video window to prevent too many captures; 2)Enabled to capture continually when Software in the Trigger Source combo box is chosen or Always enable software trigger checkbox is checked on the Options>Advanced property page;</p>
<p>Multiple</p>	<p>Multiple refers to the operation mode in which the camera receives Software trigger signal or command and export multiple frames of images. An edit box with spin (we call it Frames Box) is designed and affiliated to the Multiple button (<input type="text" value="Multiple"/> <input type="text" value="3"/> <input type="button" value="Options..."/>) for the setting of the frames to be captured; The Frames Box can be set in the range of 1~ 65535. If the Frames Box is 3, a three-frame image will be captured and exported;</p>  <p>Note: 1)Multiple capture is enabled to capture continually when Software in the Trigger Source combo box is chosen; 2) Multiple capture is enabled when Always enable software trigger is checked on the Options>Advanced property page, no matter whether Trigger Source is Software or Hardware on the Capture & Resolution group;</p>

	<p>3) If the Plan or Hardware is chosen in the Type combo box on the Options>Sequence page, the Multiple button will switch to Sequence button and the camera will use the Exposure Time and Gain in the Sequence table on this page. The captured frames will be displayed either in Show in the video window, or Show in a new window or Save to disk which can be specified on Options>Output page;</p>
<p>Sequence</p>	<p>When Sequence is clicked, the camera will start to capture the image until the specified frames in the Frames Box are captured. At the same time the Sequence button will switch to Stop button. Clicking Stop button will stop the current Sequence capture and the Stop button will switch to Sequence again for the next Sequence capture operation;</p> <p>Note:</p> <ol style="list-style-type: none"> 1) Switched from Multiple to Sequence to capture the specified frames in the edit box with spin(Frames Box) when Plan or Hardware in the Type combo box is chosen on the Options>Sequence property page; 2) If the Plan or Hardware is chosen in the Type combo box on the Options>Sequence page, the Sequence button will be enabled and the capture will use the Exposure Time and Gain in the Sequence table list below one by one on the Options>Sequence page; 3) If the Plan or Hardware is chosen in the Type combo box on the Options>Sequence page and Always enable software trigger is checked on the Options>Advanced property page, the Sequence button will not switch to Multiple button and will be enabled only when the still in Sequence enable 4) If the Plan is chosen in the Type combo box on the Options>Sequence page and the Software is chosen in the Trigger Source combo box, the Sequence button will be enabled. 5) If the Hardware is chosen in the Trigger Source combo box, the Sequence button will be disabled, but the Frame Box will still be enabled and the Sequence will switch to the Hardware Sequence capture. One Hardware trigger signal will capture the specified frames on the Frame Box using the Exposure Time and Gain in the Sequence table on Options>Sequence page; 6) Check Options>Sequence page for the related Sequence setup options;

9.3.3 The trigger capture and IO Control configurations

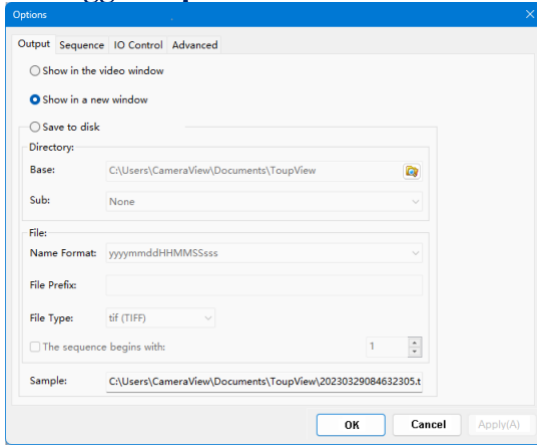

Figure 50 Options>Output page

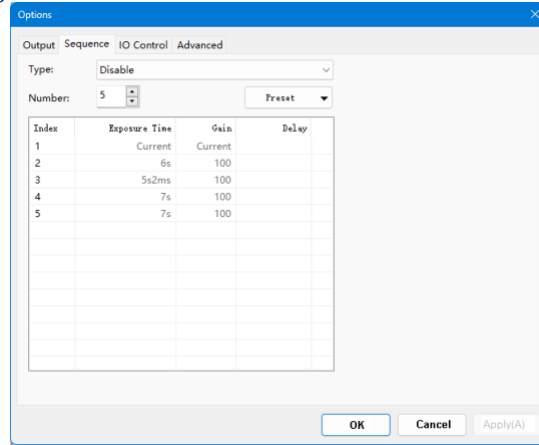

Figure 51 Options>Sequence page

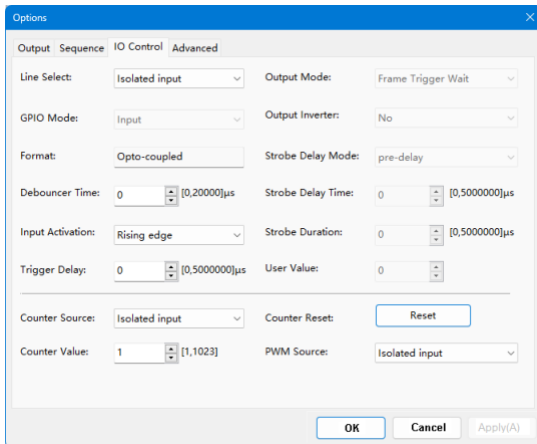

Figure 52 Options>IO Control page

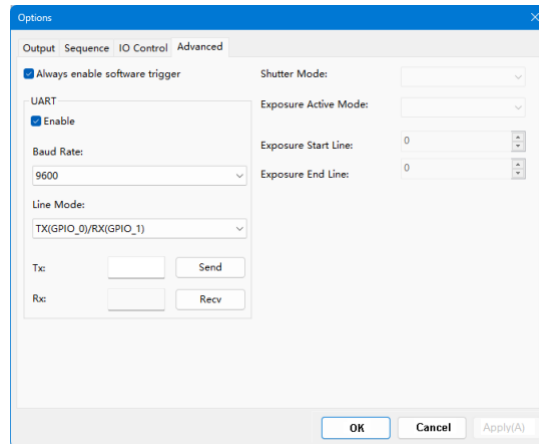

Figure 53 Options>Advanced page

The **Trigger Source** can be **Isolated input**, **GPIO0**, **GPIO1**(when configured as input), **Counter**, or **PWM** which can be configured on the **Options** property sheet. Also the camera's **Isolated output**, **GPIO0** or **GPIO1**(can be configured as **Output**) can be used as **Output** or **UART** (**GPIO0**, **GPIO1** only) applications. All of these configurations can be

realized on the [Options](#) property sheet described in Table 80 below.









About the captured file operation style, one can find it on the [Option>Output](#) page;

About the [Sequence](#) setup, one can find it on the [Option>Sequence](#) page;

About the camera pin [IO Control](#) style, one can find it on the [Options>IO Control](#) page;

About the [Always enable software trigger](#) and [UART](#) setup, [Shutter Mode](#), and [Exposure Active Mode](#), one can find it on the [Options>Advance](#) page.

Table 80 Options property sheet for Trigger Source or camera pin configuration

Pages	Items	Descriptions
Output page	Output Destination	<p>Used to set the captured frame's Output destination, can be Show in the video window, Show in a new window or Save to disk;</p> <p>When Save to disk is checked, the  button will be enabled clicking it to choose the Base directory, clicking the Sub combo box's dropdown button to choose the Sub directory;</p> <p>The File Name Format, File Prefix, File Type, and even The sequence begin with can be chosen, set, or defined.</p> <p>Note:</p> <ol style="list-style-type: none"> 1)Valid only for Sequence or Multiple capture setup; 2)For Single or Loop capture, the captured image will be always displayed on the video window;
Sequence page	Type Disable Plan Hardware	<p>Disable: If the Disable button is chosen in the Type combo box on the Options>Sequence page, the Sequence button on the Capture & Resolution page will switch to Multiple button;</p> <p>Plan: 1)If Plan is chosen in the Type combo box on the Options>Sequence page, the Multiple button on the Capture & Resolution group will switch to Sequence button;</p> <p>2) If the Software Trigger Source is chosen in the Capture & Resolution group or the Always enable software trigger is checked on the Options>Advanced property page, the Sequence button will be enabled After the Software trigger signal is arrived(By clicking Single, Loop, or Sequence button), the camera will capture frames specified in the edit box with spin  Sequence 3  (we call it Frames Box) affiliated to the Sequence button; The whole captures will use the Exposure Time, Gain and Delay in the Sequence table list under  Number 3  one by one by the software;</p> <p>3) If the Disable button is chosen in the Type combo box on the Options>Sequence page, the Sequence button on the Capture & Resolution page will switch to Multiple button;</p> <p>4) The Sequence button will be enabled only when a) the Plan in the Type combo box is chosen on the Options>Sequence page and b) he Software Trigger Source is chosen in the Capture & Resolution group or c) Always enable software trigger is checked on the Options>Advanced property page;</p> <p>Hardware: 1) if Hardware is chosen in the Type combo box on the Options>Sequence page, the Multiple button on the Capture & Resolution group will switch to Sequence button and will be disabled for Hardware trigger. But users can still set the frames number in the Frame Box on the Capture & Resolution group;</p> <p>2) After the Hardware trigger signal arrives, the camera will capture frames specified in the edit box with spin  Sequence 3  (we call it Frame Box) affiliated to the Sequence button; The whole capture will use the Exposure Time, Gain (Delay is not used) in the Sequence table list under  Number 3  one by one but stored in the camera hardware for the quick operation;</p> <p>3) If the Disable button is chosen in the Type combo box on the Options>Sequence page, the Sequence button on the Capture & Resolution page will switch to Multiple button.</p> <p>4) The Sequence button is always disabled if a) The Hardware is chosen in the Type combo box on the Options>Sequence page and b)the Hardware Trigger Source is chosen in the Capture & Resolution group;</p> <p>5) The Sequence button will be enabled if a) the Software Trigger Source is chosen in the Capture & Resolution group or b) the Always enable software trigger checkbox is checked on the Options>Advanced property page, in this case, both the Plan and Hardware Sequence capture are supported;</p>
	Number	The possible Sequence (capture) frames to be captured. If the Number is larger than the Sequence Number in the Frames Box on the Capture & Resolution group, the other Indices will be executed at the next Sequence operation one by one recycled;
	Index	The order of the Number group;
	Exposure Time	The camera Exposure Time for the specified capture Index in the Sequence capture;
	Gain	The camera Gain for the specified capture Index in the Sequence capture;
	Delay	The Delay time for the specified capture Index in the Plan Sequence capture(Valid for Plan Sequence capture only);
	Preset	Choosing Save to save the current Sequence table 's settings; Clicking Management to Rename the saved Sequence table 's setting files or Remove them from the Management

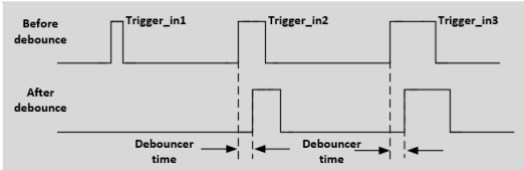
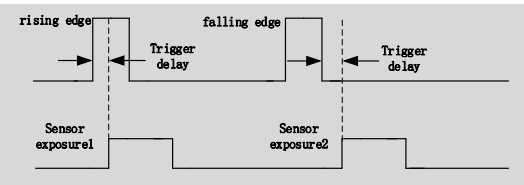
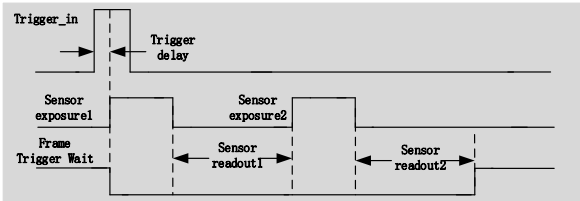
		list;
IO Control page	Line Select	Choosing which line to set. Can be Isolated input , Isolated output , GPIO0 or GPIO1 et al;
	GPIO Mode	To configure whether the line selected in Line Select is for Input or Output . Only GPIO0 or GPIO1 can be configured as either Input or Output ; If Isolated input or Isolated output is chosen, the GPIO Mode will be specified as Input or Output (Not configurable) respectively;
	Format	Specify the current selected signal's Format in the Line Select combo box, can be Opto-coupled(Isolated input, Isolated output) or TTL (GPIO0 or GPIO1) for clarity(Unconfigurable);
	Debouncer Time	Since there may be a glitch in the external trigger input signal if it directly enters into the internal logic circuit of the camera, it will cause false triggering, so the input trigger signal should be debounced. In addition, the effective pulse width of the trigger signal input by the user should be greater than the Debouncer Time , otherwise, the trigger signal will be ignored; When Isolated input , GPIO0 or GPIO1 is chosen in the Line Select combo box and GPIO0 or GPIO1 is configured as Input in the GPIO Mode combo box, the Debouncer Time will be enabled for the user to input the Debouncer Time between 0 to 20000us; 
	Input Activation	When Isolated input , GPIO0 or GPIO1 is chosen in the Line Select combo box and GPIO0 or GPIO1 is configured as Input in the GPIO Mode combo box; The Input Activation combo box will be enabled to configure the Input Activation as either Rising Edge or Falling Edge ; 
	Trigger Delay	When Isolated input , GPIO0 or GPIO1 is chosen in the Line Select combo box and GPIO0 or GPIO1 is configured as Input in the GPIO Mode combo box, the Trigger Delay will be enabled for the user to input the Trigger Delay time between 0 to 5000000us; If the Trigger Delay time is set to 1000000us, the camera will wait for 1s to capture the image after receiving the trigger signal;
Output Mode Frame Trigger Wait Exposure Active Strobe User Output	When Isolated output , GPIO0 or GPIO1 is selected in the Line Select combo box and GPIO0 or GPIO1 is configured as Output in the GPIO Mode combo box, the Output Mode will be enabled. It can be Frame Trigger Wait , Exposure Active , Strobe , or User Output . The chosen mode can be used for diversified applications; The Frame Trigger Wait signal is pulled low at the start of exposure and pulled high when the last frame of data is read out. The trigger signal input by the user should be in the valid period. If the user inputs a trigger signal when the signal is low, the trigger signal input at this time will be ignored. The following example is the case when Burst Count = 2, as shown below; 	
		Exposure Active: when this signal is high, it means the sensor is exposing. This signal can be used to control an external mobile device to remain stationary or move at low speed while the camera is at exposure. The timing diagram of the exposure valid signal is shown below;

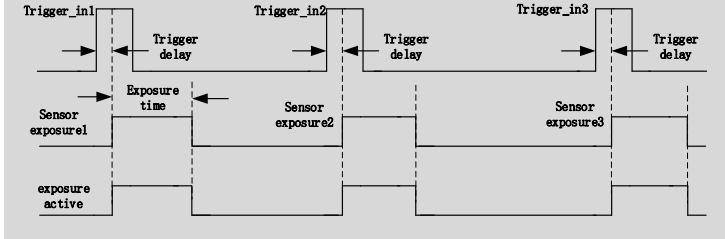
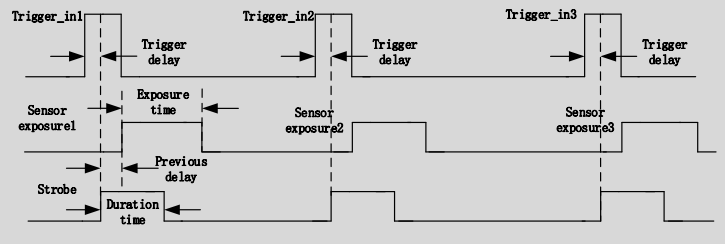
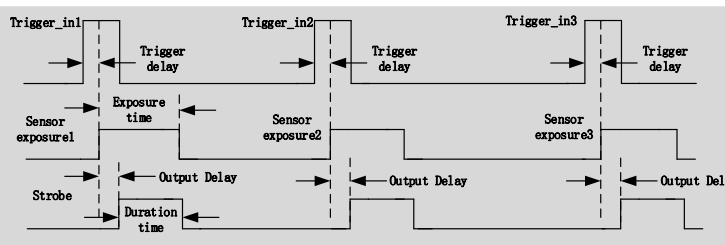
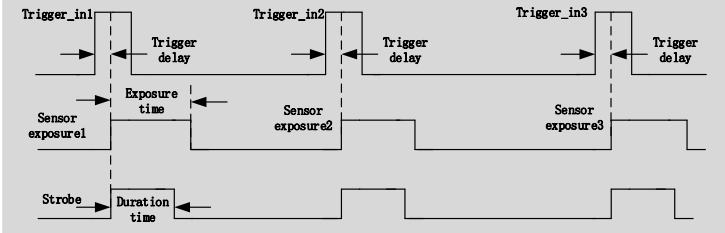
		 <p>When the relative position of the camera and the object to be photographed changes, you can refer to Exposure Active signal to prevent the captured image from being affected by movement and focus adjustment during the exposure process;</p> <p>When Strobe is chosen, Strobe Delay Mode, Strobe Delay Time, Strobe Duration will be enabled;</p> <p>When User Output is chosen, User Value will be enabled. line3, line2, line1 are the combination of GPIO1, GPIO0 and Isolated output respectively. If User Value is 001, then line GPIO1 and GPIO0 will be disabled and Isolated output will be enabled;</p> <table border="1" data-bbox="841 625 1079 709"> <tr> <td></td> <td></td> <td></td> <td>LSB</td> </tr> <tr> <td>UserOutput Value:</td> <td>1</td> <td>0</td> <td>0</td> </tr> <tr> <td>Line:</td> <td>line3</td> <td>line2</td> <td>line1</td> </tr> </table>				LSB	UserOutput Value:	1	0	0	Line:	line3	line2	line1
			LSB											
UserOutput Value:	1	0	0											
Line:	line3	line2	line1											
<p>Output Inverter</p>		<p>When Isolated output, GPIO0 or GPIO1 is selected in the Line Select combo box and Output is chosen for GPIO0 or GPIO1 in the GPIO Mode combo box, the Output Inverter will be enabled to configure the current selected line's output as either inverted or not(Yes or No).</p>												
<p>Strobe Delay Mode</p>	<p>Delay Mode</p>	<p>Strobe can be used to control external devices such as the strobe, and the effective level duration, delay time, and pre-delay time of the strobe signal can be set;</p> <p>When the Output Mode is Strobe, Strobe Delay Mode will be enabled. It can be pre-delay or delay;</p>												
<p>Strobe Time</p>	<p>Delay Time</p>	<p>When exposure starts, the strobe does not take effect immediately, and the output is delayed according to the value set by Strobe Delay Time which is between 0 to 5000000us. The Strobe Delay Mode can be pre-delay or delay; It is described below;</p> <p>pre-delay:</p>  <p>delay:</p> 												
<p>Strobe Duration</p>		<p>The high level duration of the strobe is determined by the Strobe Duration which is between 0 to 5000000us as shown below;</p> 												
<p>User Value</p>		<p>Users can input a value at User Value edit box with spin to control the line as disable or enable. Enabled when User Output is chosen in the Output Mode combo box. The logical value 0 or 1's combination of GPIO1(line3),</p>												

		<p>GPIO0(line2) and Isolated output(line1);</p> <p>When the output mode is selected as User Output, the user can input a value at User Value edit box to control the corresponding line output with 0 or 1;</p> <p>The value here is only valid for the lower three bits of a binary. For example, when line 1 and line 3 are set to User Output mode, and its User Value is set to 4 ('b100), then line 3 outputs 1, and line 1 outputs 0, as shown below.</p> <div style="text-align: center;"> </div>
	Counter Source	When Counter is chosen in the Trigger Source combo box in the Capture & Resolution group, the Counter Source can be chosen from Isolated input, GPIO0 or GPIO1 in this combo box on the Option>IO Control page;
	Counter Value	The Counter Value is used to divide the frequency of the external input trigger signal when the Counter Trigger Source is chosen in the Capture & Resolution group; See Counter in Table 79 for detail;
	Counter Reset	Click Reset button can clear the current counting process and begin a new one;
	PWM Source	When PWM is chosen in the Trigger Source combo box in the Capture & Resolution group, the PWM Source can be from Isolated input, GPIO0, or GPIO1 in this combo box et al. ;
Advanced page	Always enable software trigger	<p>When this button is checked, no matter whether Trigger Source is Software or Hardware, the software trigger buttons(Single, Loop, Multiple) are always enabled;</p> <p>If the Plan or Hardware is chosen in the Type combo box on the Options>Sequence page, the Multiple button will switch to Sequence button; The Sequence button will be enabled if a)the Software Trigger Source is chosen in the Capture & Resolution group or b) the Always enable software trigger checkbox is checked on the Options>Advanced property page, in this case, both the Plan and Hardware Sequence captures are supported;</p>
	UART	<p>There is a serial port function on the Advanced page, which can be used to communicate with external devices via serial port. Check Enable to enable this function. When enabled, GPIO0 and GPIO1 can only be used as UART transfers;</p> <p>The Baud Rate support 9600-115200. Cable Select can configure GPIO0 and GPIO1, which can be configured as TX or RX respectively. Setting a value at TX, clicking Send to send the set value out; click Accept at RX to receive the value from the external device;</p>
	Shutter Mode	Enabled if the camera support. Users can select Rolling Shutter or Global Reset ;
	Exposure Active Mode	Enabled if the camera support. Users can select Specified lines or Common exposure time ;
	Exposure Start Line	Enabled when Specified lines in the Exposure Active Mode combo box is selected. To configure when the Exposure Active signal is valid;
	Exposure End Line	Enabled when Specified lines in the Exposure Active Mode combo box is selected. To configure when the Exposure Active signal is invalid;

9.4 Cooling

There is a **Cooling** group on the left sidebar in ToupView. To enable the **Cooling** function, an external 12V power supply is required. By default, the **TEC** is turned on. One can set the **Target Temperature**. After entering the value, click "**Apply**", and the sensor temperature will gradually approach to the **Target Temperature**. At the same time, ToupView can display the current temperature in real time. And the cooling effect can reach about 10-25 degrees lower than the ambient temperature, as shown in Figure 54.

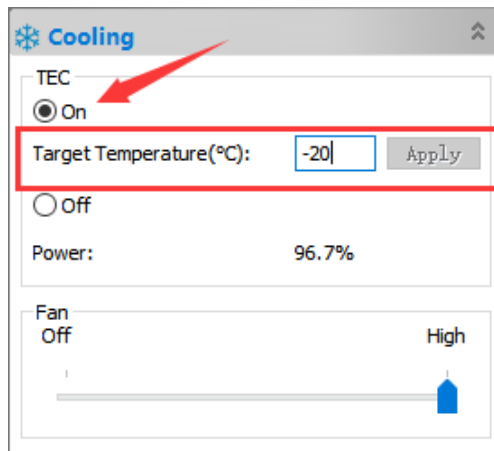

Figure 54 TEC settings

The Fan has two gears from Off to High. When High, the Fan speed reaches the highest. When Off, the Fan is turned off, the TEC is also turned off, and the power is 0, as shown in Figure 55.

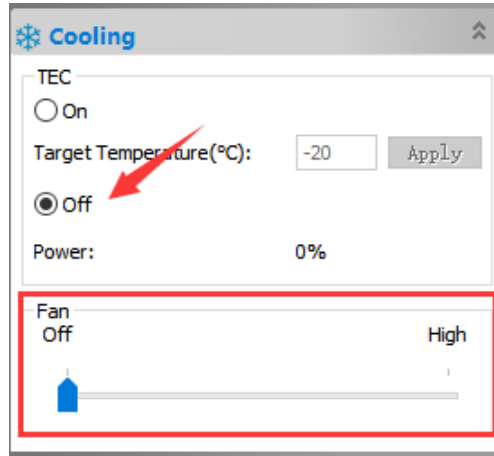

Figure 55 Fan settings

When the TEC is turned on, the Fan will automatically turn on preventing the abnormal situation such as the housing temperature is too high if the Fan stops running when the TEC is working; when the Fan is turned off, the TEC will automatically turn off.

9.5 Software development instructions

9.5.1 SDK description

The download link of the SDK is as follows:

<http://www.touptek.com/download/showdownload.php?lang=en&id=32>

9.5.2 SDK support platform

- Win32:
 - x86: XP SP3 and above; the CPU needs to support at least the SSE2 instruction set.
 - x64: Win7 and above.
 - arm: Win10 and above.
 - arm64: Win10 and above.
- WinRT: x86, x64, arm, arm64; Windows 10 and above.
- macOS: x86 and x64 bundle; macOS 10.10 and above.
- Linux: core 2.6.27 and above.
 - x86: The CPU needs to support at least the SSE3 instruction set; GLIBC 2.8 and above.
 - x64: GLIBC 2.14 and above.
 - armel: GLIBC 2.17 and above; compiled by toolchain arm-linux-gnueabi (version 4.9.2).
 - armhf: GLIBC 2.17 and above; compiled by toolchain arm-linux-gnueabi (version 4.9.2).
 - arm64: GLIBC 2.17 and above; compiled by toolchain aarch64-linux-gnu (version 4.9.2).
- Android: arm, arm64, x86, x64; compiled by android-ndk-r18b.

9.5.3 Introduction to SDK content

ToupCam series cameras support a variety of APIs, including: Native C/C++, .NET/C#/VB.NET, Python, Java, DirectShow, Twain, LabView, Matlab, etc. Compared with other APIs, Native C/C++ API as a low-level API is characterized by using pure C/C++ development without relying on other runtime libraries. The interface is simple and the control is flexible. This SDK zip package contains all the resources and information needed. The directory is as

follows:

- inc:
toupcam.h, the C/C++ header file.
- win: Microsoft Windows platform file
 - ◆ dotnet:
toupcam.cs, support C#. toupcam.cs uses P/Invoke to call toupcam.dll. Please copy toupcam.cs to your C# project for use.
toupcam.vb, support VB.NET. toupcam.vb uses P/Invoke to call toupcam.dll. Please copy toupcam.vb to your VB.NET project for use.
 - ◆ x86:
toupcam.lib, x86 lib file.
toupcam.dll, x86 dynamic library file.
democpp.exe, x86 C++ demo execute the procedure.
- x64:
toupcam.lib, x64 lib file.
toupcam.dll, x64 dynamic library file.
democpp.exe, x64 C++ demo execute the procedure.
- arm:
toupcam.lib, arm lib file.
toupcam.dll, arm dynamic library file.
- arm64:
toupcam.lib, arm64 lib file.
toupcam.dll, arm64 dynamic library file.
- winrt:
They can be applied for Dynamic library files of WinRT/ UWP (Universal Windows Platform)/ Windows Store App. They are compatible with Windows Runtime and can be referenced by Universal Windows Platform apps. If you use C# to develop UWP, you can use the toupcam.cs wrapper class.
Please pay attention to the Device Capability of uwp. Refer to how to add USB device capabilities to the app manifest. (Microsoft seems to limit the Device entry under DeviceCapability to no more than 100) demouwp.zip is a simple example of uwp. Please modify vid and pid. under DeviceCapability in the file Package.appxmanifest before compiling the run example.
- Drivers: (Cameras produced after 2017.1.1 support WinUSB, and drivers no longer need to be installed on Windows 8 and above)
The x86 folder contains the x86 kernel-mode driver files, including toupcam.cat, toupcam.inf and toupcam.sys.
The x64 folder contains the x64 kernel-mode driver files, including toupcam.cat, toupcam.inf and toupcam.sys.
- samples:
1. democpp, C++ example. This example demonstrates enumerating devices, opening devices, previewing videos, capturing images, setting resolution, triggering, saving images to files in various image formats (.bmp, .jpg, .png, etc.), wmv format video recording, Trigger Mode/Trigger Mode, IO control and so on. This example uses the Pull Mode mechanism. To keep the code clean, the WTL library used by the examples can be downloaded from this link <http://sourceforge.net/projects/wtl/>.

2. demopush, C++ example, using the Push Mode mechanism, StartPushModeV3.
3. demomfc, a simple C++ example, uses MFC as a GUI library, support opening devices, previewing videos, capturing images, setting resolution, saving images to files in various image formats (.bmp, .jpg, .png, etc.), etc. This example uses the Pull Mode mechanism.
4. demowinformcs1, take C# winform for example, it support opening devices, previewing videos, capturing images, saving images to files, and setting white balance. This example uses the Pull Mode mechanism, StartPullModeWithWndMsg.
5. demowinformcs2, take C# winform for example, it support opening devices, previewing videos, capturing images, saving images to files, and setting white balance. This example uses the Pull Mode mechanism, StartPullModeWithCallback.
6. demowinformcs3, take C# winform for example, it support opening devices, previewing videos, capturing images, saving images to files, and setting white balance. This example uses the Push Mode mechanism, StartPushMode.
7. demowinformvb, take VB.NET winform for example, it support opening devices, previewing videos, capturing images, saving images to files, and setting white balance. This example uses the Pull Mode mechanism.

- linux: Linux platform files
Udev: 99-toupcam.rules, udev rule file.

Please refer to: http://reactivated.net/writing_udev_rules.html.

- c#: toupcam.cs, Support. Net Core C#. toupcam.cs uses P/Invoke to call libtoupcam.so. Please copy toupcam.cs to your C# project for use.
- x86: libtoupcam.so, x86 version so file.
- x64: libtoupcam.so, x64 version so file.
- armel: libtoupcam.so, armel version so file, toolchain is arm-linux-gnueabi.
- armhf: libtoupcam.so, armhf version so file, toolchain is arm-linux-gnueabihf.
- arm64: libtoupcam.so, arm64 version so file, toolchain is aarch64-linux-gnu.
- android: libtoupcam.so for four architectures of Android platform arm, arm64, x86, x64.
- mac: macOS platform files.
- python: toupcam.py and example code.
- java: toupcam.java and example code (console and Swing).
- doc: SDK usage documentation, Simplified Chinese, English.
- sample:
demosimplest, the simplest example, is about 60 lines of code.
demoraw, RAW data and still shots, about 120 lines of code.

9.5.4 Third-party interface software

- directshow: DirectShow SDK and demo program.
- twain: TWAIN SDK.
- labview: Labview SDK and demo program.
- matlab: MatLab demo program.

10 CameraLink Camera Application

10.1 Connection to the CameraLink

Connect the two CameraLink cables: the CameraLink1 port on the camera is connected to the CL1 port on the capture card, the CameraLink2 port on the camera is connected to the CL2 port on the capture card.

Attention: if the camera and the acquisition card cross-linking, camera will not work. Please pay special attention.

10.2 Software installation

10.2.1 Install SDK

Windows 10 system can directly select the exe shown in Figure 56 to install SDK; For Windows 7, please install the driver shown in Figure 57.

名称	修改日期	类型	大小
SaperaLTSDKSetup_8.60.exe	2023/4/28 13:49	应用程序	413,617 KB
Xtium2-CL MX4.pdf	2023/4/28 13:59	Microsoft Edge ...	4,426 KB
xtium-cl_mx4_130000311.exe	2023/4/28 13:49	应用程序	43,574 KB

Figure 56

SaperaLTSDKSetup_8.60.exe	2023/4/28 13:49	应用程序	413,617 KB
Windows6.1-KB3033929-x64.msu	2023/8/24 10:37	Microsoft 更新独...	44,843 KB
Xtium2-CL MX4.pdf	2023/4/28 13:59	Microsoft Edge ...	4,426 KB
xtium-cl_mx4_130000311.exe	2023/4/28 13:49	应用程序	43,574 KB

Figure 57

10.2.2 Install options

The following is the interface to be selected, and the rest of the steps can be directly clicked next.

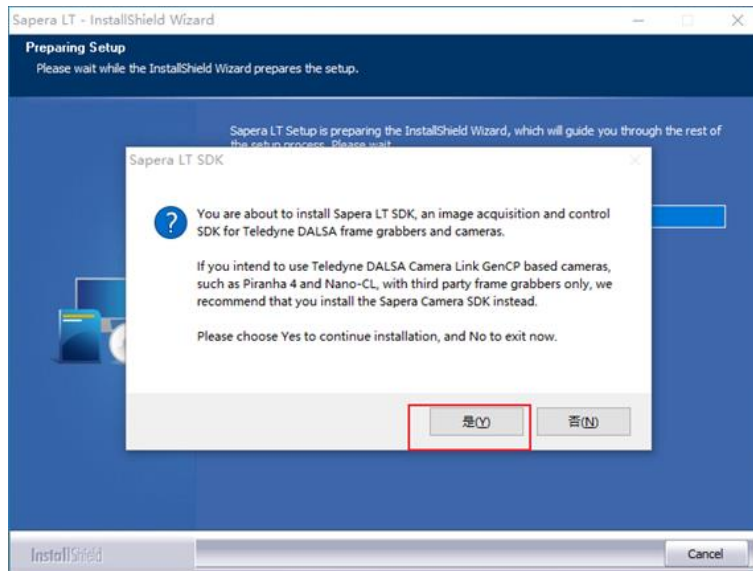

Figure 58

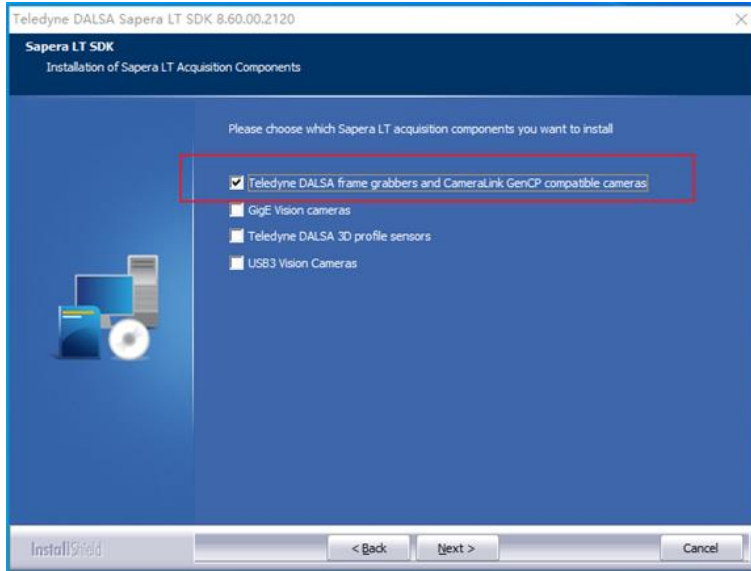

Figure 59

10.2.3 Install the driver

The exe shown in Figure 60 is the driver of the capture card (xtium-cl_mx4) currently used by our company, and the drivers of dalsa acquisition cards are different.

Capture card driver installation steps can be all click Next.

SaperaLTSDKSetup_8.60.exe	2023/4/28 13:49	应用程序	413,617 KB
Xtium2-CL MX4.pdf	2023/4/28 13:59	Microsoft Edge ...	4,426 KB
xtium-cl_mx4_130000311.exe	2023/4/28 13:49	应用程序	43,574 KB

Figure 60

Restart your computer after the installation is complete.

10.3 Configure the Dalsa capture card

10.3.1 Serial port configuration

Find the software Sapera Configuration in Figure 61 of the DALSA supporting tool, open it, change COM port mapping (optional) to the required port (currently COM2) as shown in Figure 62, and restart the computer according to the program requirements.

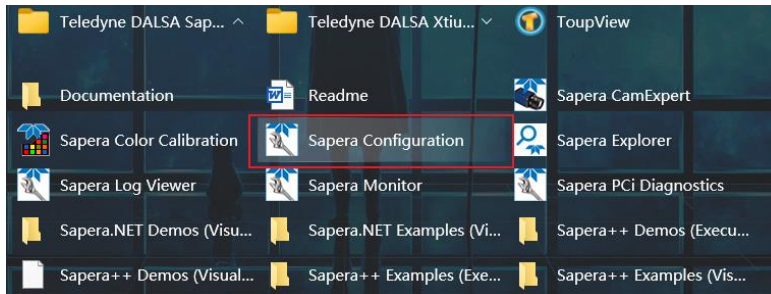

Figure 61

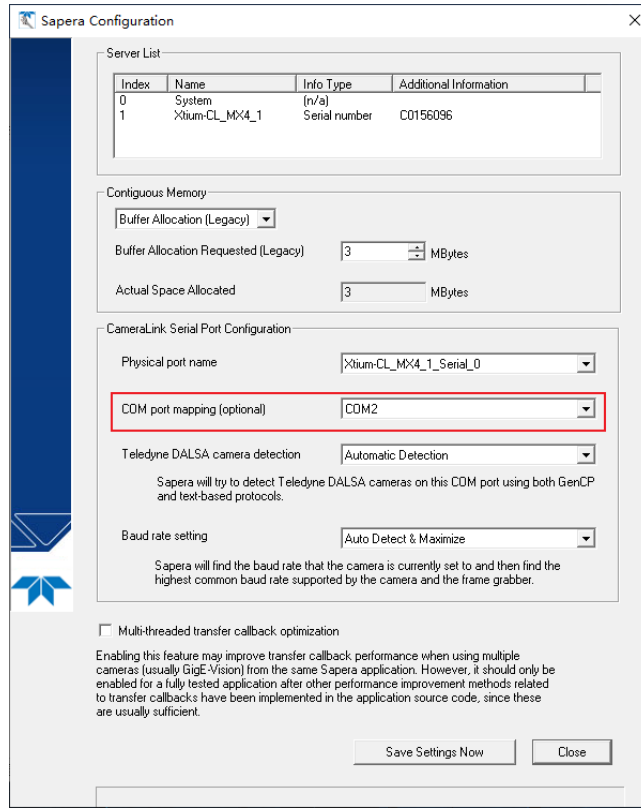

Figure 62 Serial port configuration dialog box

10.3.2 CameraLink mode configured

Open the software in Figure 63 and verify that it looks like Figure 64. If not, please click the Manual button in Figure 20 to modify the tart as shown in Figure 65, and click the tart Updat button to wait for the completion of the update. If an error occurs, please confirm whether the serial port control is turned off.

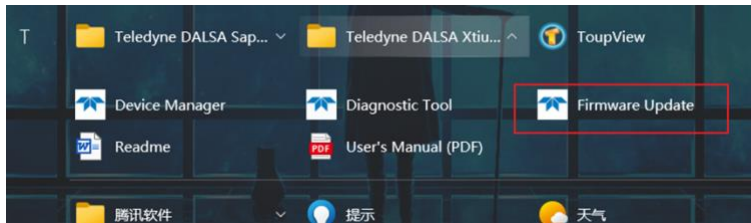

Figure 63

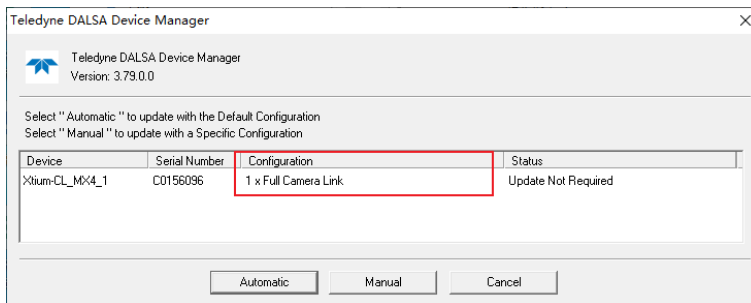

Figure 64

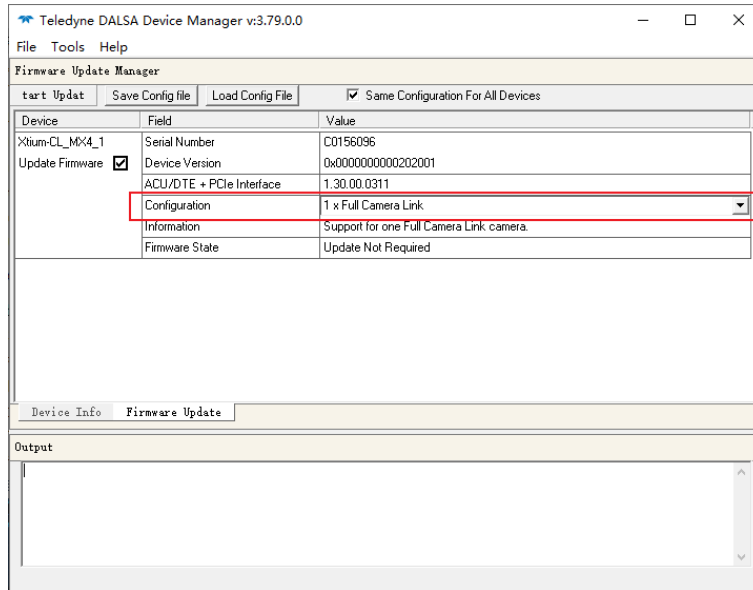

Figure 65

10.3.3 Configuring CameraLink Receiving

Opening the Spera CamExpert software of DALSA, click the arrow position in Figure 66 and select SWIR331KMA_CL_Medium_12bit_4Ports_640x512_V1.0.ccf to load the configuration information of the receiving format of CameraLink.

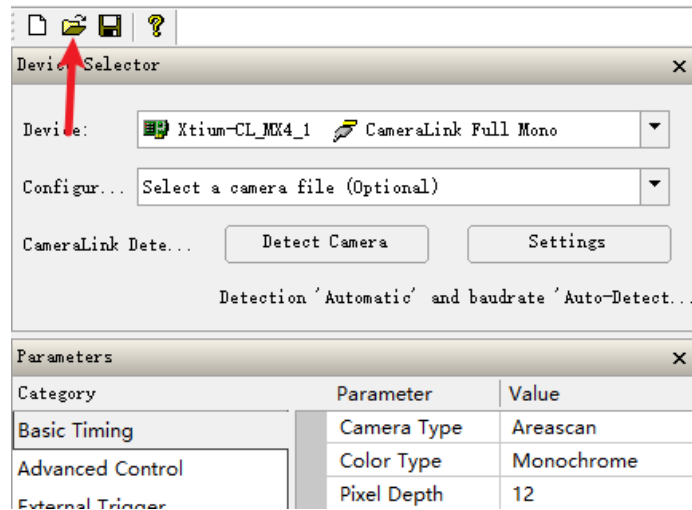

Figure 66 Load the CameraLink receive format configuration information

The arrangement is shown in Figure 67(You do not need to change the arrangement of the ccf files mentioned above).

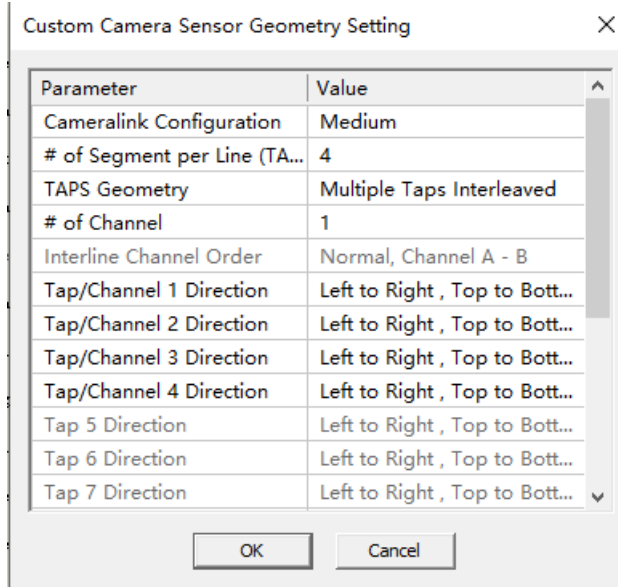

Figure 67 Arrangement

10.3.4 CameraLink Receiving the configuration content

The image below shows the resolution and bit depth Settings.

Parameter	Value
Camera Type	Areascan
Color Type	Monochrome
Pixel Depth	12
Horizontal Activ...	640
Horizontal Offs...	0
Vertical Active (...)	512
Vertical Offset (...)	0
Pixel Clock Inp...	85
Data Valid	Disabled
Camera Sensor...	Custom
PoCL	Disabled
PoCL Status	Not Active

Figure 68

The steps of Camera Sensor Geometry Setting are shown in Figure 69 and Figure 70.

Parameter	Value
Camera Type	Areascan
Color Type	Monochrome
Pixel Depth	12
Horizontal Ac...	640
Horizontal Of...	0
Vertical Active...	512
Vertical Offse...	0
Pixel Clock In...	85
Data Valid	Disabled
Camera Sens...	Custom
PoCL	Disabled
PoCL Status	Not Active

Figure 69

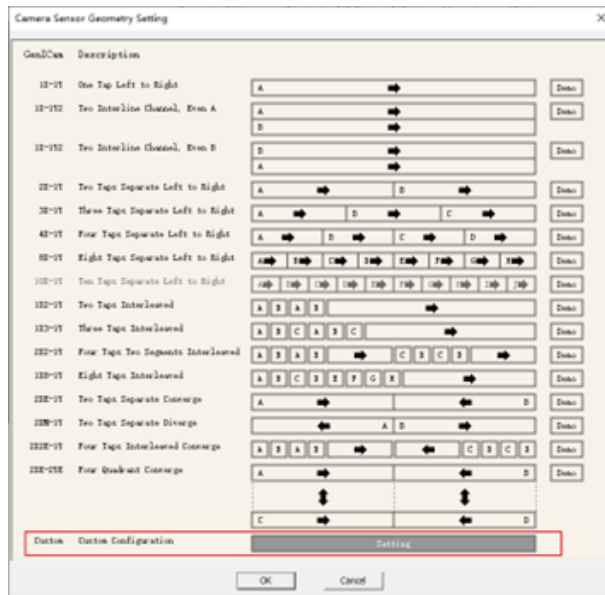

Figure 70

The Settings are as follows:

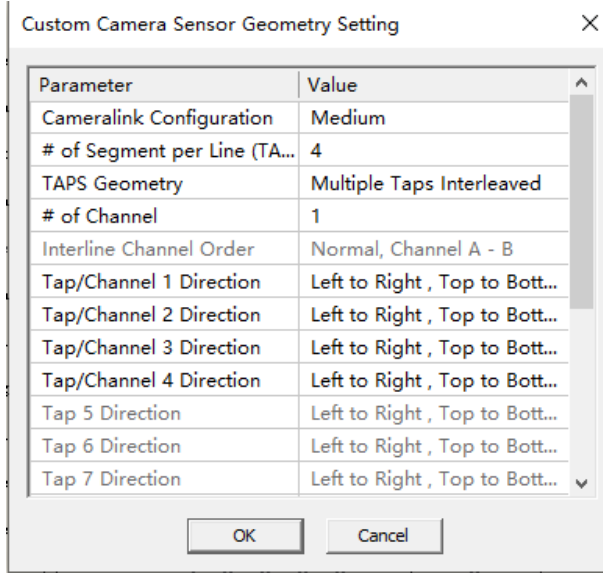

Figure 71

10.4 Using GenIcam

10.4.1 Communication Settings

Enter the interface shown in Figure 72 and set the content as shown in Figure 73.

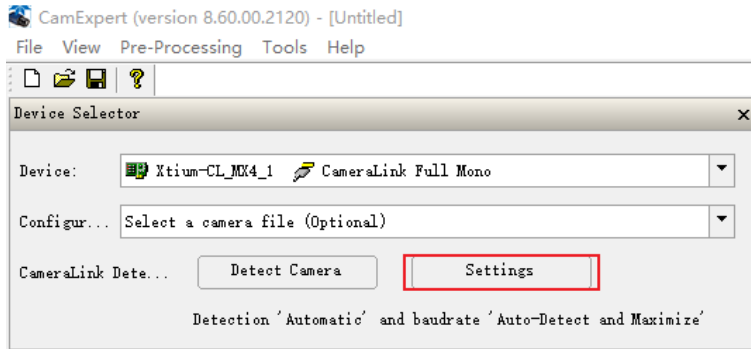

Figure 72

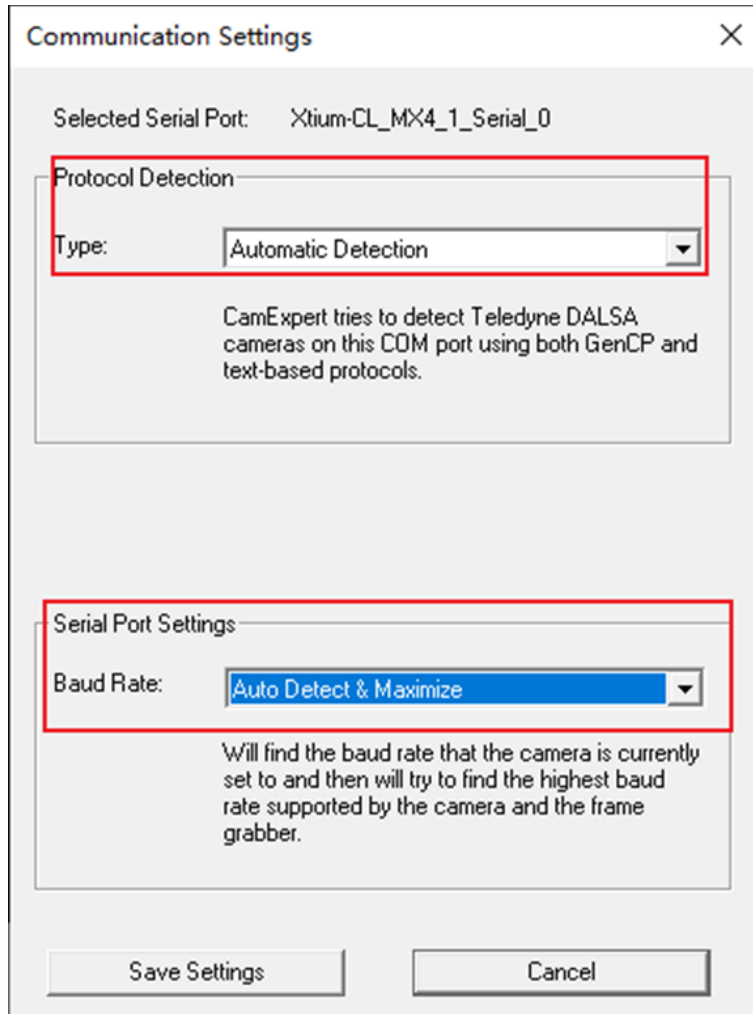

Figure 73

After the Settings are complete, properly connect the camera and restart CamExpert. Figure 74 will appear on the software interface.

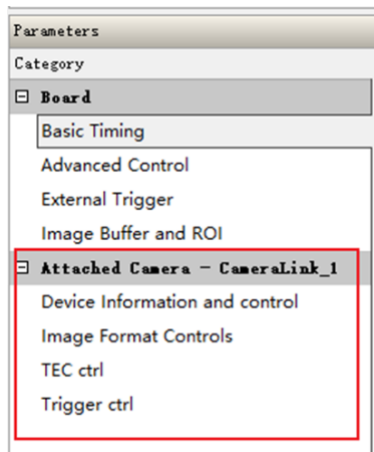

Figure 74

10.5 Description of GenIcam

10.5.1 Device Information and control

As shown in Figure 75, it contains the basic information of the equipment, including exposure time control, gain control, frame rate control and TEC temperature display.

Category	Parameter	Value
Board	Manufacturer ...	touptek hangzh
Basic Timing	Device Family	toupswir
Advanced Control	Model Name	toupswir331k
External Trigger	Serial Number	...
Image Buffer and ROI	expo time	100
	gain	Middle Gain
Attached Camera - ...	Frame Frequency	700
Device Information and ...	Deniose mode ...	Enable
Image Format Controls	Deniose level	5
TEC ctrl	TEC_temp	0.4
Trigger ctrl	Show More >>	

Figure 75

10.5.2 Image Format Controls

Figure 76 shows the ROI control.

Parameters		
Category	Parameter	Value
Board	Horizontal Offset	0
Basic Timing	Vertical Offset	0
Advanced Control	Width	640
External Trigger	Height	512
Image Buffer and ROI	Show More >>	
Attached Camera - CameraLink_1		
Device Information and control		
Image Format Controls		
TEC ctrl		
Trigger ctrl		

Figure 76

10.5.3 TEC Ctrl

As shown in Figure 77, TEC Ctrl contains TEC temperature control, TEC switch, fan switch, and TEC temperature display in degrees Celsius.

Category	Parameter	Value
Board Basic Timing Advanced Control External Trigger Image Buffer and ROI	set temp	0.0
	TEC mode select	Enable
	Fan mode select	Enable
	TEC_temp	-1.5
Show More >>		
Attached Camera - ... Device Information and ... Image Format Controls TEC ctrl Trigger ctrl		

Figure 77

10.5.4 Trigger ctrl

The trigger control content Settings are shown in Figure 78 and contain the basic trigger Settings.

Category	Parameter	Value
Board Basic Timing Advanced Control External Trigger Image Buffer and ROI	Tri mode	Disable
	Softalways	Disable
	TriSource	Opt_in
	TriActivation	rising edge
	Burst Counter	0
Attached Camera - ... Device Information and ... Image Format Controls TEC ctrl Trigger ctrl	CounterSource	Opt_in
	Counter Value	0
	PWMSource	Opt_in
	Soft trigger	Disable
	Tirgger Delay0	0
	Tirgger Delays	0
	Output Mode0	0
	DurationTime	0
	PreDelay	0
	OutputDelay	0
	UserValue	Opt_in
	TriProhibited	4100
	Counter Reset	Disable
	Debounce0	0
	Line Inverter	-Invalid value-
OutputCounter	1	

Figure 78

10.6 The main features of camera

Function	Function description
Operating mode	Operating mode: video mode or trigger mode Trigger mode: soft trigger mode or external trigger mode
GenICam	Supports the standard GenICam protocol and can control the camera through third-party software

Serial port control	Support the virtual serial port of the CameraLink capture card to control the camera, and the camera command is open
Denoise	The camera hardware incorporates denoise
Bit depth	Built-in 14bit ADC, output 12bit or 14bit valid data
Automatic exposure	Automatic exposure or manual exposure function
Gain	HG, MG, LG 3 gain modes
Frame rate	Supports precise frame rate control
ROI	Supports single-zone ROI with a maximum frame rate of 8000fps after ROI
Flip	Supports Vertical/horizontal flip
Custom dark field correction	The hardware supports up to 12 groups of user-defined dark field correction image functions
Timestamp function	Timestamps can be turned on or off. After the timestamp function is enabled, the low 8bits of 1-8 pixels, 9-16 pixels, and 17-24 pixels will be modified to: 0-7: frame number; 8-15: Frame time; 16-23: trigger signal count
Firmware update	Supports firmware online update
Pipette function	Supports the display of the gray value of the mouse pixel position
Histogram display	Supports histogram display and statistics
Plane line function	Supports the function of viewing surface data
Regional gray statistics	Support the average gray statistics function of user-defined areas
DC12V power supply and cooling system	1) When the DC12V power supply is disconnected and only the CameraLink cable is connected, the camera cannot work; 2) Connect the 6PIN aviation plug interface of the DC12V adapter to the DC12V interface on the camera. After the power is successfully turned on, the two LED lights will light up; 3) The cooling system of the camera is divided into TEC cooling sheets built in the sensor, using external heat dissipation structure and fan auxiliary heat dissipation, the working temperature can be adjusted to a specific value, the effective cooling temperature can be lower than the ambient temperature of 40°C, and the high-efficiency cooling system ensures extremely low dark current level; 4) The TEC system adopts PID algorithm control, so that TEC can accurately adjust the sensor to the target temperature, and the temperature deviation is 0.3°C;
Acquisition card adaptation	Support mainstream brand CameraLink capture card, through the virtual serial port control, there are two ways: 1) The standard GenICam protocol is used to control the acquisition card software; 2) Capture card software is used to capture and display images, and CLCtrl software is used for control.

10.7 Camera Commands

10.7.1 Basic Formats

The serial port of the camera CameraLink is used as the communication port. The baud rate of the serial port is 115200, and the serial port has 8 bits without check bit mode.

The protocol format is compatible with GENICAM gencp 1.0. For details, refer to GENICAM protocol.

The protocol instruction is realized by register access, each function is distinguished and defined by different register addresses, and the protocol data is divided into general part and special part. The protocol data is preceded by the general part and followed by the special part. The general part is fixed to the length of 16 bytes, and the length of the special part is variable according to the different length of the function.

The general 16-byte format is described as follows (all fields in the general part are in Big-Endian format with high bytes before them) :

Suppose the sixteen bytes of data are D0, D1, D2, D3, D4, D5, D6, D7, D8, D9, D10, D11, D12, D13, D14, D15. For command execution, the protocol stipulates that the host computer is the active initiator and the device is the passive responder.

1. D0, D1 is two prefix bytes, fixed as 0x01 and 0x00.
2. D2 and D3 are the check words of the universal partial data. The check part ranges from D6, D7 to D14, and D15 adopts double-byte CRC redundancy check, with the high byte coming first (Big-Endian).
3. D4 and D5 are the check words for the total protocol data. The check part runs from D6 and D7 to the end of the entire protocol data. Double-byte CRC redundancy check is also adopted, with the high byte in the front (Big-Endian).
4. D6 and D7 are channel ids. At present, the device channel is fixed to 0, and the data is 0x00 and 0x00.
5. D8 and D9 are common flag fields. For the upper computer, if the value is 0x40, 0x01 indicates that the normal function request is sent and the device needs to respond. If the value is 0x00, 0x01 indicates that the normal function request is sent and the device does not need to respond. For the response of the device, the

field is 0x00. 0x00 indicates that the device receives the response correctly and there is no exception.

6. D10 and D11 are command ids, which are general command definition fields. For the upper computer, the values are 0x08 and 0x00 when reading data and 0x08 and 0x02 when writing data. For the device, the value is 0x08, 0x01 when it responds to read data, 0x08, 0x03 when it responds to write data.
7. D12, D13 indicates the length of the dedicated part data.
8. D14 and D15 are sequence ids. For the upper computer, the sequence ID needs to be increased by one for each command sent. The sequence ID remains the same for a device-side response to ensure that the host machine receives confirmation that the device-side instruction is executed correctly.

10.7.2 Dedicated Part Format

For the special part of the format is mainly divided into two read and write registers (register and length field is fixed in the Big-Endian format before the high byte, the rest of the data can be Big-Endian or Little-Endian, according to the custom)

1. Format description of the special part when the upper computer reads the register data

The whole dedicated data length is 12 bytes, if the data is R0, R1, R2, R3, R4, R5, R6, R7, X0, X1, X2, X3, where R0~R7 is the register address that needs to be read; X0, X1 is fixed to 0x00, 0x00; X2, X3 are the length of the data to be read (the length is the legal length defined by the register, and the length of each register is specified).

2. Format description of the special part when the device responds to the upper computer reading register data

The whole private data is the data that needs to be read, there are no other fields; The length varies according to the length of the data read, such as X1, X2, X3..... Xn; The length of the read data is n.

3. Format description of the special part of the upper computer when writing register data

When the upper computer writes register data, the special part of the data consists of two parts: register and data, such as R0, R1, R2, R3, R4, R5, R6, R7, X1, X2, X3..... Xn; R0 to R7 indicates the register address (REG_ADDR). X1 to Xn indicates the data to be written. The length of the data to be written is n, which is the legal length specified by the register.

4. Format description of the special part when the device responds to the host computer to write register data

When the device successfully writes data from the host computer, the dedicated data part of the device response is fixed as 0x00, 0x00, 0x00, 0x00.

10.7.3 Definition of each register

ADDR_BASE = 0x0000000020000000

REG_ADDR = ADDR_BASE + ADDR_OFFSET

Number	Register function	Register address (ADDR_OFFSET)	Register value	default parameters	data length	R/W	Data sequence
1	ROI columns	0x070	32 to 640- Column start position	0	4byte	RW	little
2	ROI column starting position	0x080	0~608	640	4byte	RW	little
3	ROI rows	0x090	4 to 512- The starting position of the line	0	4byte	RW	little
4	ROI row starting position	0x0A0	0~508	512	4byte	RW	little
5	Exposure	0x200	16~100000(us)	100	4byte	RW	Big
6	Gain	0x210	0/1/2(Hg/Mg/Lg)	1	4byte	RW	Big
7	Frame rate control	0x230	1~700	700	4byte	RW	Big
8	Denosing level	0x280	1~10	5	4byte	RW	Big
9	Algorithm control	0x2b0	0bit: Detect defective pixel switch 1bit: Dark field correction switch 2bit: Denoise switch	7	4byte	RW	Big
10	Defective pixel	0x320			4byte	W	Big

	reload						
11	TEC Temperature Setting	0x330	T(°C)=data/10, complement-on-two	0	4byte	RW	Big
12	TEC temperature reading	0x340	T(°C)=data/10, complement-on-two		4byte	R	Big
13	TEC switch control	0x350	1 is on and 0 is off	1	4byte	RW	Big
14	Fan control	0x360	1 is on and 0 is off	1	4byte	RW	Big
15	Automatic dark field switch	0x370	1 is on and 0 is off	1	4byte	RW	Big
16	Manual dark field selection	0x380	1~15	1	4byte	RW	Big
17	Auto exposure switch	0x390	1 is on and 0 is off(Not supported yet)	0	4byte	RW	Big
18	tri_mode	0x400	0-Normal Mode 1-Trigger Mode	0	4byte	RW	Big
19	soft_always_en	0x410	0-soft disable 1-soft always enable	0	4byte	RW	Big
20	tri_source_i	0x420	trigger source: 0-Opt_in 1-GPIO_0 2-GPIO_1 3-counter 4-PWM 5-software	0	4byte	RW	Big
21	tri_activation_i	0x430	0-rising edge; 1-falling edge; 2-level high; 3-level low	0	4byte	RW	Big
22	burst_counter_i	0x440	continuous acquisition 0-65535	0	4byte	RW	Big
23	counter_source_i	0x450	0-Opt_in 1-GPIO_0 2-GPIO_0	0	4byte	RW	Big
24	counter_value_i	0x460	Frequency division coefficient	0	4byte	RW	Big
25	pwm_source_i	0x470	0-Opt_in 1-GPIO_0 2-GPIO_1	0	4byte	RW	Big
26	IO_link	0x480	0bit: GPIO_0: 0-input,1-output 1bit: GPIO_1: 0-input,1-output	0	4byte	RW	Big
27	soft_start	0x490	software trigger	0	4byte	W	Big
28	tri_delay_0_i	0x4a0	when the Opt_in trigger assert, the start of exposure will delay 0-32xffff ffff(cycle)	0	4byte	RW	Big
29	tri_delay_1_i	0x4b0	when the GPIO_0 trigger assert, the start of exposure will delay 0-32xffff ffff(cycle)	0	4byte	RW	Big
30	tri_delay_2_i	0x4c0	when the GPIO_1 trigger assert, the start of exposure will delay 0-32xffff ffff(cycle)	0	4byte	RW	Big
31	tri_delay_s_i	0x4d0	when the software trigger assert, the start of exposure will delay 0-32xffff ffff(cycle)	0	4byte	RW	Big
32	output_mode_0_i	0x4e0	Opt_out output mode: 0-Frame Trigger Wait 1-Exposure Active 2-Strobe 3-User output	0	4byte	RW	Big
33	output_mode_1_i	0x4f0	GPIO_0 Output mode: 0-Frame Trigger Wait 1-Exposure Active 2-Strobe	0	4byte	RW	Big

			3-User output				
34	output_mode_2_i	0x500	GPIO_1 output mode: 0- Frame Trigger Wait 1-Exposure Active 2-Strobe 3-User output	0	4byte	RW	Big
35	duration_time_i	0x510	Strobe duration time:effective time 0- 32xffff ffff(cycle)	0	4byte	RW	Big
36	pre_delay_i	0x520	advance the exposure time 0-32xffff ffff(cycle)	0	4byte	RW	Big
37	output_delay_i	0x530	later than exposure time 0- 32xffff ffff(cycle)	0	4byte	RW	Big
38	user value	0x540	Opt out--user value	0	4byte	RW	Big
39	tri_prohibited_i	0x550	next trigger rising prohibited time 4100~32xffff ffff(cycle)	4100	4byte	RW	Big
40	counter_reset	0x560	When counter_reset assert, the counter of trigger will be reseted	0	4byte	W	Big
41	debounce 0	0x570	debounce time: 0-20000us	0	4byte	RW	Big
42	debounce 1	0x580	debounce time: 0-20000us	0	4byte	RW	Big
43	debounce 2	0x590	debounce time: 0-20000us	0	4byte	RW	Big
44	line_inverter	0x5a0	1-enable	3'b111	4byte	RW	Big
45	output_counter_i	0x5b0		1	4byte	RW	Big
46	pause	0x5c0		0	4byte	RW	Big
47	Frame count cleared to zero	0x5d0	0bit: frame_clr 1bit: tri_clr 2bit: time_clr 3bit: all_clr	0	4byte	W	Big
48	Frame count display switch	0x5e0		0	4byte	RW	Big
49	Dark field threshold control	0x5f0	0-16384	16383	4byte	W	Big
50	Version	0x3a0	MCU Version + maximum frame rate + Firmware version + Firmware date		16byte	R	Big
51	Read mode switching	0x1f0	0: IWR(Integrate while reading) 1: ITR(Integrate then read)	1	4byte	RW	Big

10.7.4 Camera instruction example

Set the exposure time command:

01 00 B7 C8 91 E0 00 00 40 01 08 02 00 0C 00 28 00 00 00 00 20 00 02 00 00 00 03 E8

Set exposure time: 1000 = 0x03E8, sequence ID is 0x28, expressed as instruction 0x28 sent, which can always be 0.

Double-byte CRC redundancy check:

B7 C8 = !(00 00 + 40 01 + 08 02 + 00 0C + 00 28)

91 E0 = !(00 00 + 40 01 + 08 02 + 00 0C + 00 28 + 00 00 + 00 00 + 20 00 + 02 00 + 00 00 + 03 E8)

Read the exposure time command:

01 00 B7 E2 95 DE 00 00 40 01 08 00 00 0C 00 10 00 00 00 00 20 00 02 00 00 00 00 04

Here the sequence ID is 0x10

Read exposure time Return content:

01 00 F7 EA F7 22 00 00 00 00 08 01 00 04 00 10 00 00 00 C8

This returns 200us.

10.8 CL SDK & CLView application

10.8.1 CL SDK

The camera control supports two modes: 1) Controlled through private SDK development kit; 2) Controlled by GenICam interface.

10.8.2 CLView application



Figure 79 CLView Software interface

CLView software can achieve complete control of the camera, and open source to customers to use, while providing technical support.

Description of the main functions of CLView software:

Serial port control;

Exposure time control;

Gain mode control;

ROI control;

Frame rate control;

Trigger mode control;

Dark field correction control;

TEC and Fan control;

Refrigeration temperature control;

Real-time frame rate display;

Real-time temperature monitoring;

Save picture;

Video;

Update online;

Accept customer OEM functions customized.

10.8.3 CLCtrl software

The camera can capture and display images through the software CameraLink capture card, and use the CLCtrl software to control. Start the CLCtrl software first, and then start the acquisition card software after obtaining the control of the serial port.

